



HD88

720P HD Outdoor Camera
Installation Manual

****Compatible with Insite GOLD and SWAN Server****



HD88 Bus / Ethernet Wiring

Wire the HD88 camera with a CAT5e or higher cable. Connect the two twisted pairs to the Green (Data) and Clock (Y) of the panel bus and two twisted pairs for the Ethernet lines. The maximum CAT5e cable length is 50 meters. When using Ethernet do NOT use Green (Data) and Yellow (Clock) in one twisted pair, but rather separate them into different twisted pairs as shown below.

Use a separate minimum 18 gauge wire for the power. If your power is not coming from the panel or a bus power supply then you will also need to connect the solid blue of the CAT5e cable to the negative (-) of the camera to have a common ground.

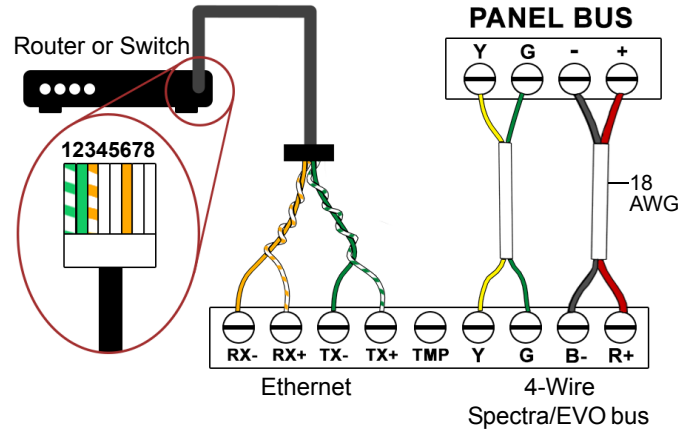

Introduction

The HD88 is an outdoor 720P HD camera with built-in sound, pet immune security motion detector, with Ethernet and WiFi. It provides up to 30 minutes of internal Recording on Trigger memory space, or 16GB to 256Gb SD card that can be added for additional recording space.

Installing the HD88

Unscrew and remove cover



Mount back on wall or bracket

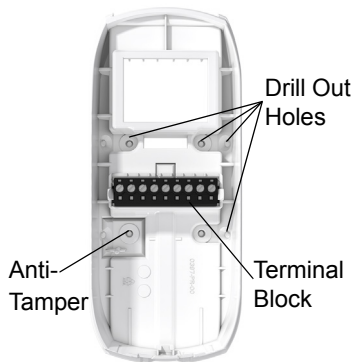

Lock and Tamper

If you are installing the HD88 near any reflecting surface, please note that it may affect the quality of the night vision due to the IR reflection.

Bracket Installation

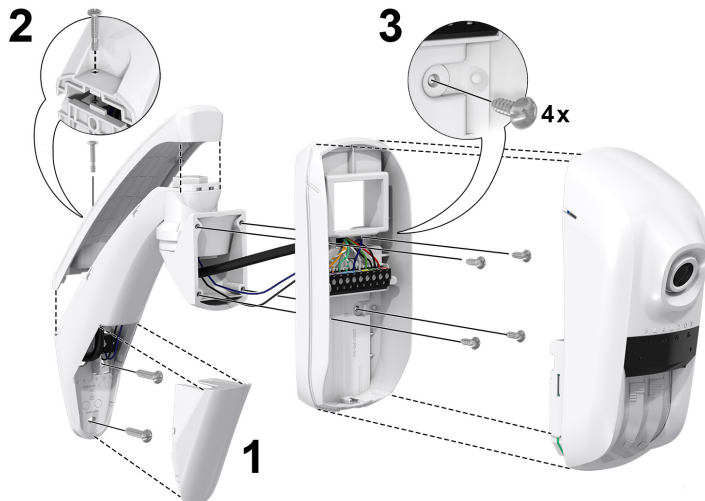

If wall bracket tamper is connected, tamper will automatically be detected by the camera. Tamper will follow recognition settings set in the panel.

CAT5E Connection

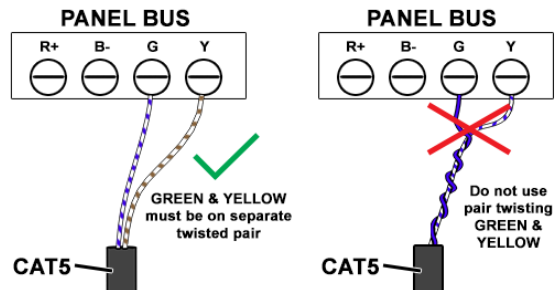

Note: Green (Data) and Yellow (Clock) need to be on separate pairs otherwise bus errors will occur.

HD88 WiFi Wiring

Wire the HD88 camera with a standard 4-wire bus cable. Connect the Yellow and Green to the Green (Data) and Yellow (Clock) of the panel bus.

Use a separate 18 gauge (minimum) wire for the power. If your power is not coming from the panel or a bus power supply then you will also need to connect the Black of the 4-wire bus cable to the negative (-) of the camera to have a common ground.

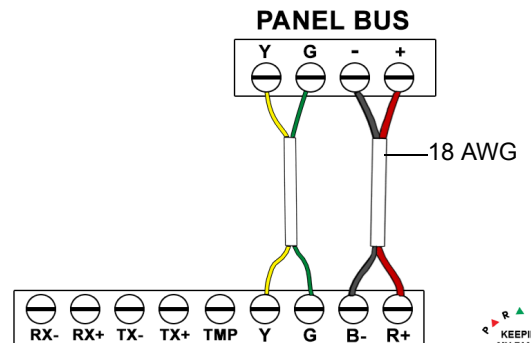

HD88 Wiring Table

Recommended Wire Assignment		Ethernet Connector	
Bus Label	Wire Color	Ethernet Connector	Wire Color
RX-	Orange	1	Green striped
RX+	Orange striped	2	Green
TX-	Green	3	Orange striped
TX+	Green striped	4	
Y	Brown striped	5	
G	Blue striped	6	Orange
B-	Black (18 AWG)	7	
R+	Red (18 AWG)	8	

WiFi Wire Assignment		Bracket Wire Assignment	
4-Wire Bus Label	Wire Color	Bus Label	Wire Color
Y	Yellow	TMP	Blue
G	Green	B-	Black
B-	Black (18 AWG)		
R+	Red (18 AWG)		

Creep Zone/Pet Selection

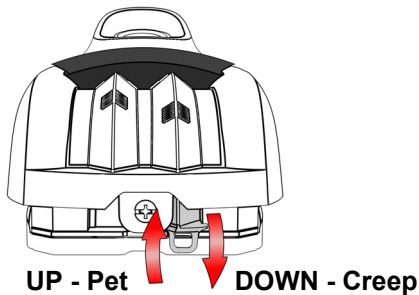

Remove detector assembly. When selector is UP, Pet Mode; when DOWN, Creep Zone is active and there is no Pet Immunity. Above 2.4m Pet Immune should be OFF (lever down Pet OFF, see installation height note*.

Installation Height:

Pet Immune ON - 2.0m/6.6ft to 2.4m/7.8ft

Pet Immune OFF - 2.0m/6.6ft to 2.8m/9ft (lever down)*

***For installations higher than 2.6m, when needed, tilt the detector down a few degrees for best detection results; use of a bracket is recommended.**

Registration LED Status Indicators

Network Status	LED Functionality
HD88 is not connected to a local WiFi network	LED and LED will flash intermittently
HD88 is connected to a local network but failed to poll the SWAN Server	LED is set to On and LED is Flashing
HD88 is connected to a local network and succeeded in polling the SWAN Server	LED is set to On and LED is set to On

SD Card Installation

An SD card can be inserted into the HD88 in order to provide additional recording time. Please note that if using Record On Trigger, an SD card must be inserted into the camera as shown.

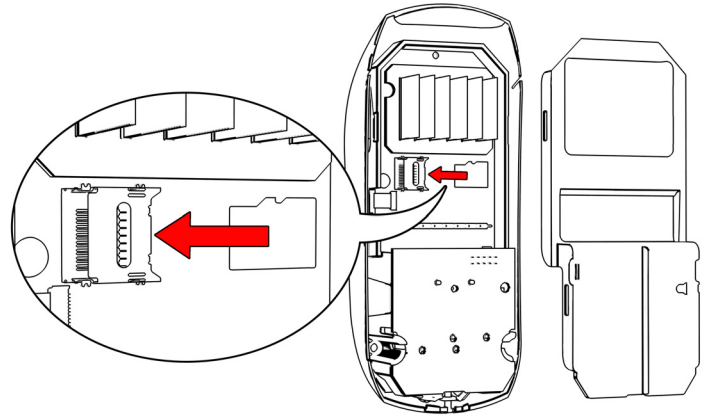

LED Status Indicators

Other than PIR detection, LEDs are active when lock mechanism is open.

LED	Functionality	LED Display
TX	Digiplex/Spectra Data TX	Flashing green: Data transmission Off: No data transmission
RX	Digiplex/Spectra Data RX	Flashing green: Data reception Off: No data reception
	Firmware upgrade in progress.	Flashing purple
	VOD*	Blue on
	Power-up	Flashing blue
	Locate mode	Flashing blue
	No connection to panel bus	Flashing red
	Bus low power	Flashing red
	PIR detection	Red on for 3 seconds
	Active Wi-Fi	Green on
	LAN 10/100Mb link	Green on: LAN active

*VOD On/Off LED is controlled by the Master **ONLY**, using the Insite GOLD application.

HD88 Camera Set Up and Configuration

1 Launch the Insite Gold app

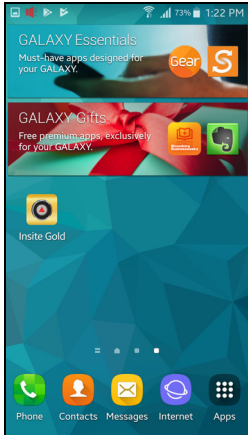

2 Select **New Installation** and then the **Create** button.

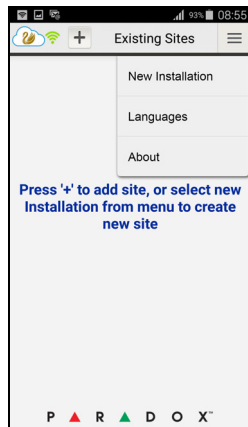

3 Type in the **Panel Serial Number, Site ID, Client's Email Address** and **Installer Email**.

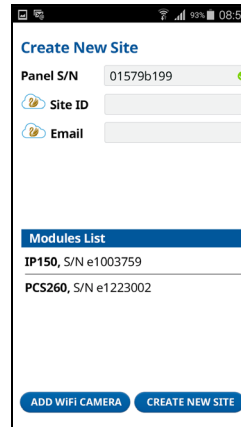

4 To add a WiFi Camera, press **Add WiFi Camera**. If you are not configuring a WiFi Camera, skip to Step 10.

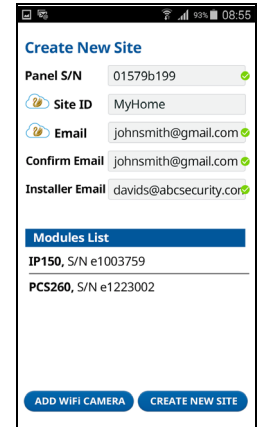

5 Select the WiFi network that the camera will be registered to.

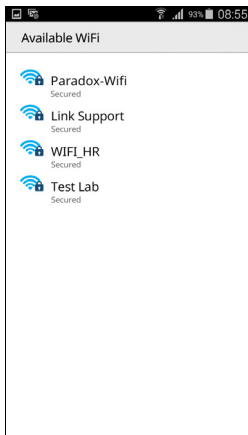

6 Enter the **WiFi password** and press continue.

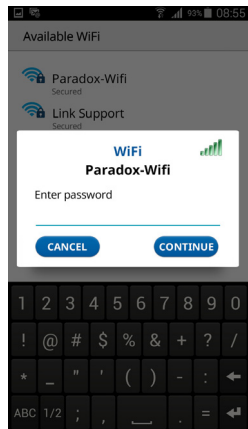

7 A QR code will be generated. Present the QR code to the camera lens. Ensure tamper is open by unscrewing screw at the bottom of the HD88.



8 The HD88 WiFi Camera will then be displayed in the modules list with a WiFi symbol next to it. Press **Configure** to modify settings.

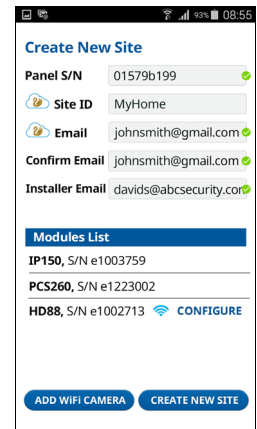

9 Configure your settings and press **Save** when completed.

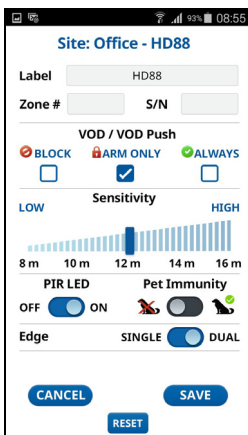

10 Press **Create New Site**. A **Site Created** message will appear. The system will send you an email.

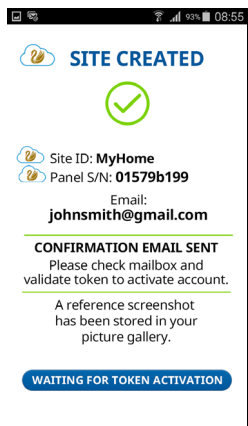

11 Retrieve your email and click **Activate**. You will then be prompted to choose the type of activation for your subscription.

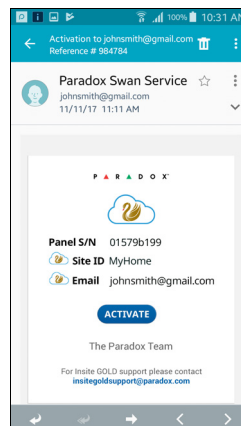

12 Your site will then be created and displayed in the app.

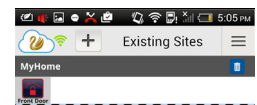

PIR Detector Beam Patterns

Top View

Camera View

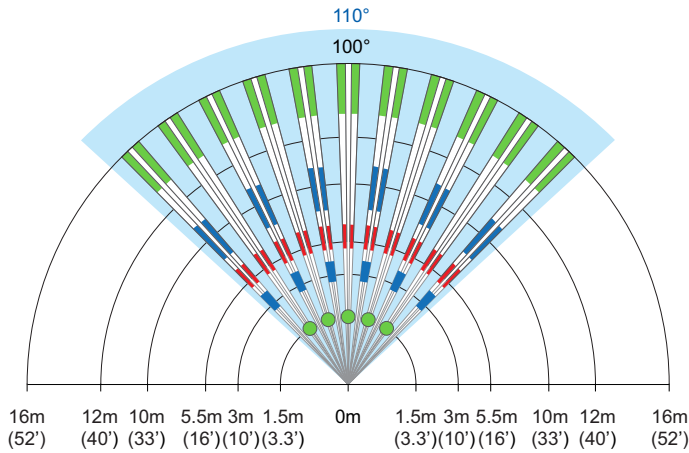

Side View

Camera View

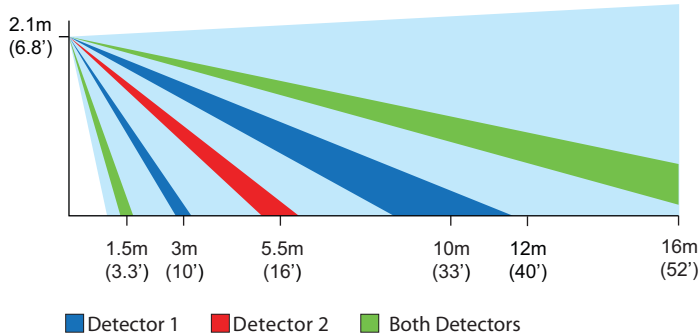

Technical Specifications

Image Resolution	1280 x 720
Image Sensor Type	1.4 mega pixels, CMOS sensor, 7V/LUX.Sec
Streaming Video	720p H.264 10 FPS
HD Audio	16 bit, 24 KHz sampling rate, 32 Kb/s mono
Pre-event recording	-3.0 sec. pre-trigger
Internal storage	15 minutes alarm and 15 minutes ROT/VOD File length - 10 sec. 3 min. detection dependent
PIR Sensor / Lens	2x dual element/Mironel lens
Pet Immune	True Paradox Pet Immune
Detection Speed	0.2 m/s to 2.5 m/s (0.6 ft/s to 11.5 ft/s)
Voltage Input	Nominal: 12VDC, range 9-16VDC
Current Consumption Max	350mA - IR illumination ON 250mA - IR illumination OFF 100mA - System lost AC / Battery operation
Dimensions (H x W x D)	16.8 x 6.8 x 7.4 cm (6.6 x 2.7 x 2.9 in)
Operating Temperature	-40° C to +60° C (-40° F to 140° F)
Compliance	CE, EN 50131-2-2 Grade 2 Environmental Class II
Installation Height	2.1m - 2.7m (7ft - 9ft)
Installation options	Wall or corner, swivel bracket optional
Compatibility	EVOHD, EVO192, SP5500, SP6000 and SP7000

Warranty

For complete warranty information on this product, please refer to the Limited Warranty Statement is found on the website: www.paradox.com/terms or contact your local distributor. Specifications may change without prior notice.

Patents

US, Canadian and international patents may apply. Paradox is a trademark or registered trademark of Paradox Security Systems (Bahamas) Ltd.