

Fire and Burglary Alarm System

EVO192

EVO192

Installation Guide

Warranty

For complete warranty information on this product, please refer to the Limited Warranty Statement found on the website www.paradox.com/terms. The terms and conditions are subject to change without notice, from time to time, in Paradox's sole discretion. We invite you to visit our website on a regular basis for the latest Limited Warranty Statement. Your use of the Paradox product signifies your acceptance of all warranty terms and conditions. Please ensure that your use of the Paradox product is in compliance with local, national, and international laws.

© 2014 Paradox Security Systems Ltd. All rights reserved. Specifications may change without prior notice. US, Canadian and international patents may apply. Paradox Insight and Paradox are a trademarks or registered trademarks of Paradox Security Systems (Bahamas) Ltd. or its affiliates in Canada, the United States and/or other countries.

This product is manufactured in Canada.

Paradox
780 Industrial Boulevard
St-Eustache, Quebec
Canada, J7R 5V3
Tel: (450) 491-7444
Fax: (450) 491-2313

Table of Contents

| | |
|---|-----------|
| Table of Contents | 3 |
| Chapter 1 Introduction | 11 |
| 1.1 EVO192 – Residential Fire and Burglar Alarm and Commercial Burglar Alarm System | 11 |
| 1.2 Features of EVO192 Controller | 11 |
| 1.3 Minimum Configuration | 12 |
| 1.4 System Operation | 12 |
| Chapter 2 System Installation | 13 |
| 2.1 Safety Warnings | 13 |
| 2.2 Location & Mounting | 13 |
| 2.3 Recommended Installation Procedure..... | 13 |
| 2.4 Mounting the EVO192 Controller, HUB2, ZX8, IP150..... | 14 |
| 2.5 Mounting the K641 | 15 |
| 2.6 Mounting the TM50..... | 15 |
| 2.7 Mounting the RTX3 | 15 |
| 2.8 Wiring..... | 15 |
| 2.9 Earth Ground..... | 17 |
| 2.10 AC Power..... | 17 |
| 2.11 Backup Battery | 17 |
| 2.12 Auxiliary Power Terminals..... | 17 |
| 2.13 Bell/Siren Output | 17 |
| 2.14 False Alarm Reduction | 18 |
| 2.15 Programmable Outputs..... | 18 |
| 2.16 Keyswitch Connections | 18 |
| 2.17 Calculating Power Requirements..... | 19 |
| 2.18 Keypad Zone Connections | 21 |
| 2.19 Addressable Zone Connections | 22 |
| 2.20 Double Zone Connections | 24 |
| 2.21 Combus Connections..... | 24 |
| 2.22 Fire Circuits..... | 25 |

| | | | |
|------------------|------|---|-----------|
| | 2.23 | Telephone Line Connections..... | 26 |
| | 2.24 | Built-in RTC..... | 27 |
| Chapter 3 | | Programming Methods | 28 |
| | 3.1 | Paradox Memory Key | 28 |
| | 3.2 | Module Broadcast | 28 |
| | 3.3 | Programming Through BabyWare..... | 29 |
| | 3.4 | Programming Through a Keypad..... | 29 |
| | 3.5 | Module Programming Mode | 30 |
| Chapter 4 | | Zone Programming..... | 31 |
| | 4.1 | Zone Programming..... | 32 |
| | 4.2 | Zone Numbering | 32 |
| | 4.3 | Zone Doubling (ATZ) | 33 |
| | 4.4 | Zone Definitions..... | 33 |
| | 4.5 | Zone Partition Assignment..... | 35 |
| | 4.6 | Zone Options..... | 35 |
| | 4.7 | Input Speed | 39 |
| | 4.8 | EOL on Hardwire Zones | 39 |
| | 4.9 | Keypad Numbering | 39 |
| Chapter 5 | | Remote Control Programming | 40 |
| | 5.1 | Hardware Requirements | 40 |
| | 5.2 | Remote Control Template..... | 40 |
| Chapter 6 | | Keyswitch Programming..... | 42 |
| | 6.1 | Keyswitch Numbering | 42 |
| | 6.2 | Keyswitch Definitions..... | 42 |
| | 6.3 | Keyswitch Partition Assignment..... | 43 |
| | 6.4 | Keyswitch Options..... | 43 |
| Chapter 7 | | Testing and Maintenance | 45 |
| | 7.1 | ZX8 Expansion Module | 48 |
| | 7.2 | Programming Locations | 48 |
| | 7.3 | Testing and Maintenance | 48 |
| | 7.4 | Call Waiting Cancel..... | 53 |

| | | | |
|------------------|------|---|-----------|
| | 7.5 | Testing and Maintenance | 53 |
| Chapter 8 | | Arming and Disarming Options..... | 55 |
| | 8.1 | Arming Follows Partition..... | 55 |
| | 8.2 | Trouble Latch..... | 55 |
| | 8.3 | Restrict Arming on Supervision Loss..... | 55 |
| | 8.4 | Restrict Arming on Tamper..... | 55 |
| | 8.5 | Restrict Arming on AC Failure | 55 |
| | 8.6 | Restrict Arming on Battery Failure..... | 55 |
| | 8.7 | Restrict Arming on Bell or Auxiliary Failure..... | 56 |
| | 8.8 | Restrict Arming on TLM Failure..... | 56 |
| | 8.9 | Restrict Arming on Module Troubles | 56 |
| | 8.10 | Timed Auto-Arming | 56 |
| | 8.11 | No Movement Auto-Arming | 56 |
| | 8.12 | Auto-Arming Options..... | 57 |
| | 8.13 | Switch To Stay Arming..... | 57 |
| | 8.14 | Always Force Arm when Regular Arming | 57 |
| | 8.15 | Auto Force on Stay Arming..... | 58 |
| | 8.16 | Follow Zone Switches to Entry Delay 2 | 58 |
| | 8.17 | One-Touch Features | 58 |
| | 8.18 | Exit Delay..... | 58 |
| | 8.19 | Keypad Lock-out Feature | 59 |
| | 8.20 | Bell Squawk | 59 |
| | 8.21 | Ring-back | 60 |
| | 8.22 | Maximum Bypass Entries..... | 60 |
| | 8.23 | Display "Bypass" If Armed..... | 60 |
| Chapter 9 | | Alarm Options | 61 |
| | 9.1 | Bell/alarm Output | 61 |
| | 9.2 | Bell Cut-off Timer | 61 |
| | 9.3 | Wireless Transmitter Supervision Options | 61 |
| | 9.4 | Police Code Timer | 62 |
| | 9.5 | Tamper Recognition Options..... | 62 |
| | 9.6 | Keypad Panic Options | 63 |

| | | |
|-------------------|---|-----------|
| Chapter 10 | Event Reporting..... | 65 |
| 10.1 | Reporting Enabled..... | 67 |
| 10.2 | Report Codes..... | 67 |
| 10.3 | Report Arming and Disarming..... | 71 |
| 10.4 | Monitoring Station Phone Number..... | 72 |
| 10.5 | Account Number..... | 73 |
| 10.6 | Account Number Transmission..... | 73 |
| 10.7 | Reporting Formats..... | 73 |
| 10.8 | Event Call Direction..... | 74 |
| 10.9 | Pager Delay..... | 75 |
| 10.10 | Recent Close Delay..... | 75 |
| 10.11 | Power Failure Report Delay..... | 75 |
| 10.12 | Power Failure Restore Report Delay..... | 76 |
| 10.13 | Repeat Pager Report Code Transmission..... | 76 |
| 10.14 | Auto Test Report..... | 76 |
| 10.15 | Disarm Reporting Options..... | 76 |
| 10.16 | Zone Restore Report Options..... | 76 |
| 10.17 | Auto Report Code Programming..... | 77 |
| 10.18 | Closing Delinquency Timer..... | 77 |
| Chapter 11 | Dialer Options..... | 78 |
| 11.1 | Telephone Line Monitoring..... | 78 |
| 11.2 | Tone/Pulse Dialing..... | 78 |
| 11.3 | Pulse Ratio..... | 78 |
| 11.4 | Busy Tone Detection..... | 78 |
| 11.5 | Switch To Pulse..... | 79 |
| 11.6 | Bell On Communication Fail..... | 79 |
| 11.7 | Keypad Beep on Successful Arm or Disarm Report..... | 79 |
| 11.8 | Dial Tone Delay..... | 79 |
| 11.9 | Call Waiting Cancel..... | 79 |
| Chapter 12 | VDMP3 Voice Module..... | 81 |
| 12.1 | VDMP3 Installation Instructions..... | 81 |
| 12.2 | Feature activation (PGMs)..... | 81 |

| | | | |
|-------------------|-------|---|-----------|
| | 12.3 | VDMP3 Setup Instructions | 82 |
| Chapter 13 | | Programmable Outputs..... | 84 |
| | 13.1 | PGM Activation Event..... | 84 |
| | 13.2 | PGM Deactivation Option | 84 |
| | 13.3 | Flexible PGM Deactivation Option..... | 84 |
| | 13.4 | PGM Deactivation Event | 85 |
| | 13.5 | PGM Timer | 85 |
| | 13.6 | PGM1 Becomes a 2-wire Smoke Detector Input* | 85 |
| | 13.7 | PGM Test Mode..... | 85 |
| | 13.8 | PGM Initial Status | 86 |
| Chapter 14 | | System Settings and Commands..... | 87 |
| | 14.1 | Hardware Reset..... | 87 |
| | 14.2 | Software Reset | 87 |
| | 14.3 | Installer Code Lock..... | 88 |
| | 14.4 | Daylight Savings Time | 88 |
| | 14.5 | Daylight Savings Time Schedule..... | 88 |
| | 14.6 | Battery Charge Current | 89 |
| | 14.7 | Combus Speed | 89 |
| | 14.8 | Transmit Zone Status on Serial Port | 89 |
| | 14.9 | Serial Port Baud Rate..... | 89 |
| | 14.10 | Partitioning..... | 89 |
| | 14.11 | Shabbat Feature..... | 90 |
| | 14.12 | Installer Function Keys | 90 |
| | 14.13 | Module Reset..... | 91 |
| | 14.14 | Locate Module | 91 |
| | 14.15 | Module Programming | 91 |
| | 14.16 | Module and Label Broadcast | 91 |
| | 14.17 | System Date & Time | 91 |
| | 14.18 | Quick Module Scanning..... | 91 |
| | 14.19 | Module Scanning | 91 |
| | 14.20 | Serial Number Viewing..... | 92 |
| | 14.21 | Power Save Mode | 92 |

| | | |
|-------------------|---|------------|
| 14.22 | Auto Trouble Shutdown | 92 |
| 14.23 | No AC Fail Display | 92 |
| 14.24 | Multiple Action Feature | 92 |
| 14.25 | System Labels | 92 |
| Chapter 15 | Access Codes | 97 |
| 15.1 | Installer Code | 97 |
| 15.2 | Access Code Length | 97 |
| 15.3 | System Master Code | 97 |
| 15.4 | Programming Access Codes | 97 |
| 15.5 | User Options | 98 |
| 15.6 | Partition Assignment | 100 |
| | Automatic Report Code List | 101 |
| | Contact ID Report Code List | 104 |
| | Keypad Installation Instructions | 106 |
| | Connecting the Keypads | 106 |
| | Connecting Keypad Zones..... | 106 |
| | Programmable Output..... | 106 |
| | Keypad Specific Instructions | 106 |
| | K641R Access Control Connection..... | 108 |
| | Programming..... | 109 |
| | Message Programming K641/K641R..... | 109 |
| | K641 Programming..... | 110 |
| | Programmable Output Options..... | 111 |
| | K641R Programming | 112 |
| | Access Control Options..... | 114 |
| | DGP2-648BL Programming..... | 117 |
| | Programmable Output Options..... | 120 |
| | Guidelines for Locating Smoke Detectors and CO Detectors | 121 |
| | Smoke Detectors | 121 |
| | CO detectors..... | 121 |
| | Fire Escape Planning | 123 |
| | EVO192 CP-01 Implications as of June 13th, 2014 | 125 |
| | • The control unit must be installed with a local sounding device and an off-premise transmission for SIA communication format.K641/K641+/TM50 Must be in the Installa- | |

| | |
|---|------------|
| tion guides | 127 |
| EVO192 BOARD LABELLING | 127 |
| ADD THESE SECTIONS IN THE PROGRAMMING GUIDE, INSTALLER MANUAL AND/OR USER MANUAL | 128 |
| CHANGE THESE DEFAULTS IN THE PROGRAMMING GUIDE, INSTALLER MANUAL. | 128 |
| ADD THESE NOTES TO THE INSTALLER MANUAL | 129 |
| ADD THESE NOTES TO THE USER MANUAL | 130 |
| UNDOCUMENTED CHANGES..... | 130 |
| EVO192 CP-01 Installer Programming Quick Reference Chart SIA False Alarm Reduction | |
| 131 | |
| Warnings | 133 |
| Index | 141 |

1.1 EVO192 – Residential Fire and Burglar Alarm and Commercial Burglar Alarm System

1.1.1 System Description

The EVO192 is a Residential Fire and Burglar Alarm and Commercial Burglar Alarm System consisting of Controller EVO192, 8-Zone Expansion Module ZX8, HUB Module HUB2, IP Communication Module IP150, Hardwired Keypads K641 and TM50, Wireless Expansion Module RTX3.

The EVO192 Controller consists of 8 on-board zone inputs (16 with zone doubling) that is expandable to a maximum of 192 zones via the 4-wire combus. The EVO Controller features up to 999 users, 8 partitions, 32 doors and can support up to 254 modules in any combination.

The EVO192 system provides the highest level of protection for use in Mercantile, high-security military and government sites, luxurious residential homes and any place where maximum security is essential. These systems are designed to be easy to use, and the modular concept of these systems provides installers with labor-saving features that make expanding, installing and servicing these systems quick and convenient.

The EVO192 Controller is connected to Detection Devices protecting different zones of the premises. These Zones can also be divided into different Partitions.

Keypads (K641 and TM50) are connected to the Control Panel in order to command, control and program the system. In addition to the Bells connected to the Control Panel, the keypads are also used for annunciation and indication of the information of the system such as events, alerts, warnings.

When required, expand the number of zones in the EVO192 system by adding ZX8 and RTX3 expansion modules¹ anywhere and in any combination on the 4-wire combus. Modules are connected to the combus at the most convenient location and then their zone inputs are assigned to the desired zone and partition. Also, only a module's used inputs are assigned to zones in the system.

EVO192 also supports 32 virtual zones in addition to its security zones. Virtual zones can be used to automate PGM (Programmable Output) activations without occupying a security zone and without affecting the system's security functions. The EVO192 system is a logical solution to every installer's security.

1.2 Features of EVO192 Controller

- Digital combus:
- Provides constant power, supervision and two-way communication between the control panel and all its modules
- Supports up to 127 modules
- Connect modules up to 914m (3000ft) from the panel²
- Sabotage-proof technology without additional wiring
- 8 on-board zones (16 w/ zone doubling) expandable to 192 zones via 4-wire combus
- Automatic Daylight Saving Time feature
- 2 on-board solid-state relays PGM outputs (+ 3 optional), negative or positive triggering
- PGM1 can be used as a 2-wire smoke input³
- Built-in-real-time clock backup battery
- 1 supervised bell output, auxiliary output and telephone line
- Push button software reset (reset to default values and restart)
- Push button to activate or deactivate the Auxiliary output

1 – Connection of non ETL/UL listed component will void the ETL listing

2- Connect according to the wiring requirements described in the Wiring Diagram

3 – 2-Wire Smoke Detector was not evaluated by ETL

- Fits in a 28cm x 28cm x 7.6cm (11in x 11in x 3in) metal box
- 5 on-board solid-state PGM outputs, negative or positive triggering
- Supports up to 254 expansion bus modules
- 999 user codes
- 8 partitions
- 2048 events buffered

ETL Note: For Mercantile installations or Residential Fire Alarm installation of the system, use only the minimum system configuration. Do not connect additional modules.

1.3 Minimum Configuration

The Paradox Fire and Burglary system in the minimum configuration contains:

- EVO192 and Battery inside an 11x11x3 Metal Box,
- Compatible Listed Bell connected to the EVO192 Bell Output,
- K641 Keypad,
- RTX3 Wireless Module.

1.4 System Operation

Once the EVO192 system is set up and programmed, as described and explained in this manual, the operation of the systems is done using the Keypads for control and indication.

Once inside the premises, the users should either have the system Disarmed or Armed in Stay mode (described in details further down this manual).

While users are departing the premises it is recommended to set the system to ARM mode.

When a detection unit is activated it is sending the detection/taper/trouble signals to the controller, which processes them. The keypads communicate the status of the zones as processed by the controller.

Note: Programming, Maintenance and System Testing is done using one of the keypads, as described under the relevant parts in the manual.

Note: Connecting any non-UL/ETL components will void the UL/ETL certification.

2.1 Safety Warnings

1. Before accessing the system modules for maintenance make sure the power is disconnected and the battery is not attached
2. To prevent risk of shock, disconnect telephone line at telco jack before servicing this unit.
3. To prevent risk of electric shock, disconnect AC battery and phone cord BEFORE Servicing.

2.2 Location & Mounting

For modules and detectors see the component instructions for recommendations. Also see *Guidelines for Locating Smoke Detectors and CO Detectors* on page 121 and see *Fire Escape Planning* on page 123 for recommendations regarding smoke and fire detector locations and Fire Escape planning.

For the 11"x11" and 8" x10" boxes containing the system components, select a site that is not accessible to intruders.

Note: Before mounting the cabinet, know which components will be installed in this cabinet and place the stand-offs for each component into the proper holes in the cabinet. There are 5 stand-offs for the EVO192 panel and 4 for each of the other components. There are also stick on stand-offs packed with the components should you want to place the components elsewhere within the cabinet.

Note: Install an anti-tamper switch for each box and connect each one to 24 hour zones inputs on the EVO192 controller.

Pull all cables into the cabinet and prepare them for connection before mounting the circuit board into the back of the cabinet. Select a centralized installation site on the main floor that is not easily accessible to intruders and leave at least 5cm (2in) around the panel box to permit adequate ventilation and heat dissipation. The installation site should be dry and close to an AC source, ground connection, Ethernet connection, and telephone line connection. Avoid installation near or in the path of strong RF fields (i.e. neon lights, computers), on or near metal objects, circuit breaker boxes, air conditioner and heater ducts since they may cause interference and reduce sensitivity and may result in false alarms. Avoid installing the control panel in the basement.

Note: For recommended locations of detectors, bells, sirens etc. see specific the device installation guide.

2.3 Recommended Installation Procedure

1. Connect a small group of modules, including a K641 keypad.
2. Connect the battery and AC power. Enter section **[4000]** (see *section 14.20* on page 92). Only the Clock Loss trouble and/or Bell Absent trouble should appear. Verify the connection if a module does not appear in section **[4000]**, or if a module trouble occurs.
3. Disconnect AC power and the battery, follow steps 2, 3 and 4 for other modules.
4. If modules were removed, enter **[4005]**(see *section 14.18* on page 91).

2.4 Mounting the EVO192 Controller, HUB2, ZX8, IP150

2.4.1 Tamper Switch

1. Insert the tamper kit TK278 into the slot in the box.
2. Mark the hole.
3. Drill the hole in the switch bracket.
4. Using a metal washer screw the switch bracket to the wall (you may need an anchor).
5. Wire one of the switch wires to one of the on board zone inputs and the other to COM.
6. Configure this zone to a 24h burglary zone.
7. Screw the cabinet to the wall using the proper screws (and anchors if required). Make sure the Anti-tamper switch is installed before you screw the cabinet to the wall.

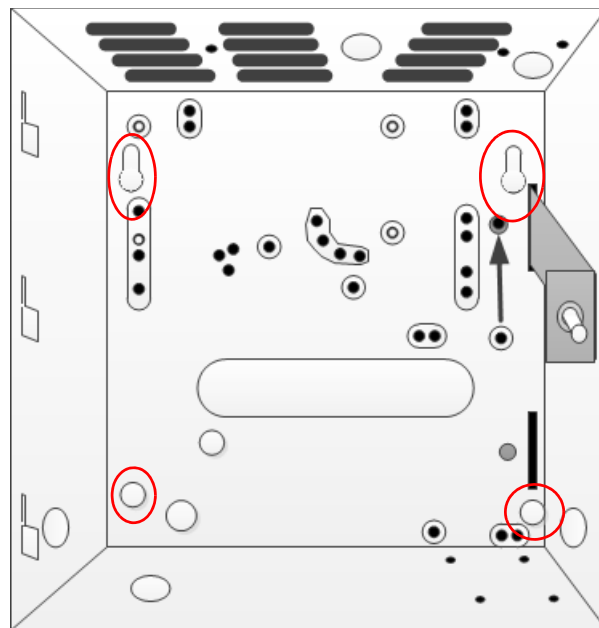
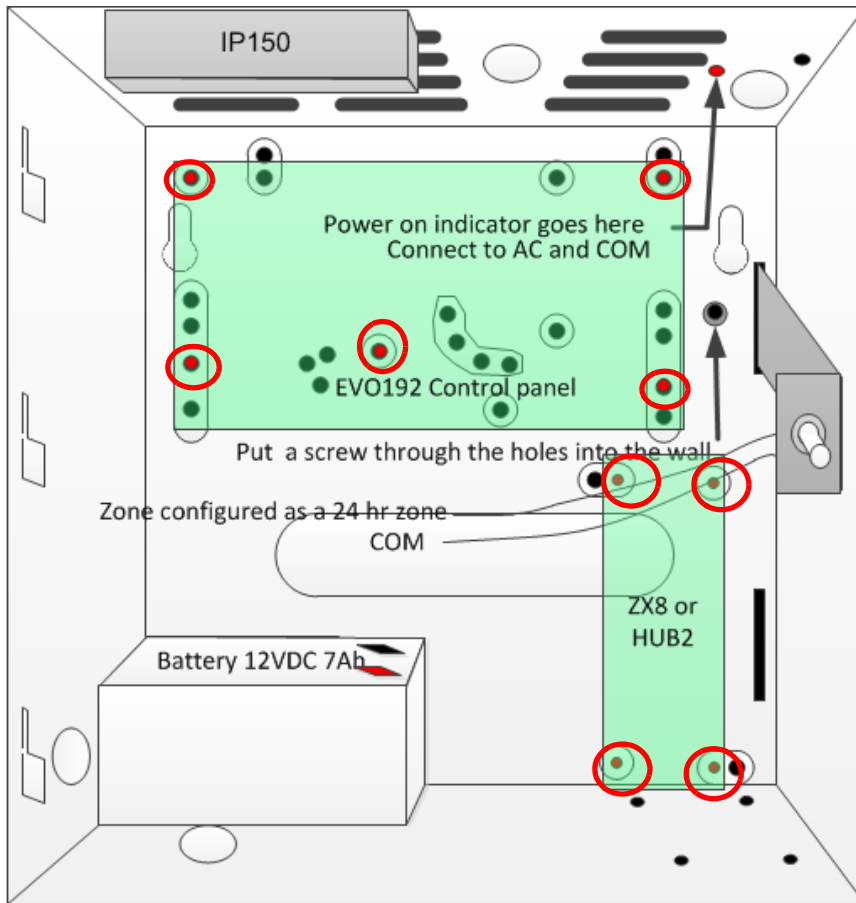

Figure 1 – Screw holes for Mounting Cabinet on the Wall



Location for the EVO192 board mounting pins. There are 5 mounting pins.

Location for the Tamper switch.

Location for the HUB2 /ZX8 board mounting pins. There are 4 mounting pins.

Use either the regular stand-offs or the stick on kind of pins found in the parts packages.

The ZX8 or HUB 2 can also be installed in a separate 11x11x3 metal box.

Figure 2 – Mounting the EVO Panel and the HUB2 in an 11 x 11 metal box

2.5 Mounting the K641

Waiting for Daniel

2.6 Mounting the TM50

For mounting instructions refer to the TM50 manual TM50-EI01.

2.7 Mounting the RTX3

For mounting instructions refer to the RTX3 manual RTX3-EI11.

2.8 Wiring

EVO192 Wiring Diagram

12Vdc 7Ah Rechargeable Lead-Acid backup battery

AUX LED and AUX control button
Activates and deactivates the auxiliary output

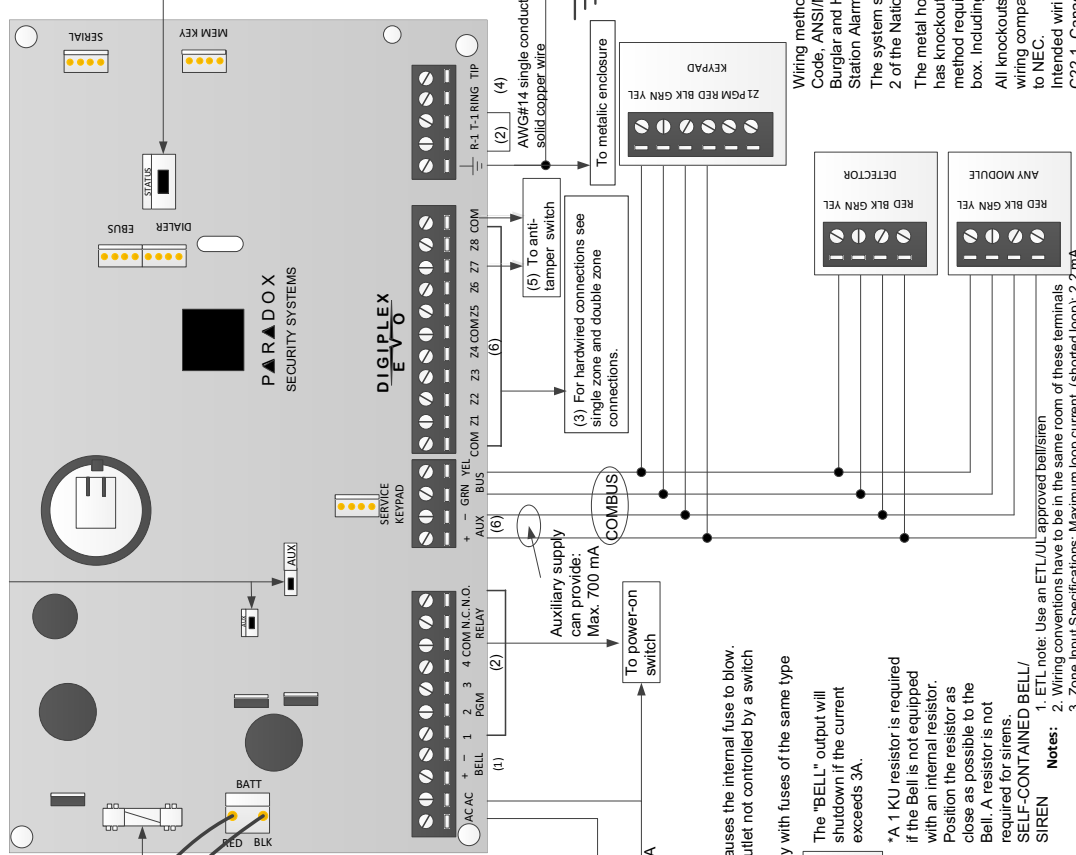

Caution: Disconnect the battery before replacing the fuse.

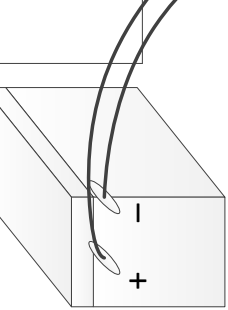

Battery Capacity for emergency standby at least 4 hours

WARNING: To prevent risk of electric shock, disconnect AC battery and phone cord BEFORE Servicing.
Mise en Garde: Ne pas connecter à une prise contrôlée par un interrupteur. Le système doit être vérifié au moins une fois tous les trois (3) ans par un technicien qualifié.

For residential installations use transformer made by Universal Power Group model: UB1640W

For US: UL/ETL Listed Class 2 wall/building 120VAC/60Hz power supply with restraining means.
For Canada: CSA/ULC ETLc Listed Class 2 Power Supply with NO restraining means.

Transformer Requirements: 120VAC/17VAC, 40VA max. 700mA 1.1a
Auxiliary Supply can provide: 120VAC/17VAC, 40VA max. 700 mA
Automatic Shut Down Usable Battery Charge Currents: 850mA max.

Do not short the terminals of the transformer together. This causes the internal fuse to blow. The transformer must be connected to a 230 VAC, 24-hour outlet not controlled by a switch other than an approved over-current protection device. For continued protection against risk of fire, replace fuses only with fuses of the same type and rating.

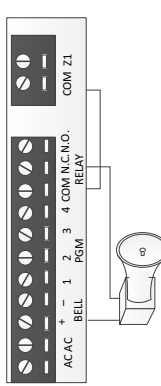
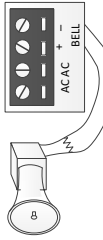

*A 1 KΩ resistor is required if the Bell is not equipped with an internal resistor. Position the resistor as close as possible to the Bell. A resistor is not required for sirens. SELF-CONTAINED BELL/SIREN

The sum total of the current draw from the bell/siren and the AUX must be limited to 2.0A. Exceeding this limit will overload the panel power supply and lead to complete system shutdown.

Red "STATUS" LED
Flashing — indicates proper operation
Always on — panel is using a phone line
Fast Flash — indicates a control panel failure
Off — Control panel error

The COMBUS supports a maximum of 254 (EVO192) modules.

Although external power supplies can be used to provide power to modules connected far from the control panel the total distance of all runs of wire combined cannot exceed 914m (3000 ft.). For example if ten runs of wire measuring 305m (1000 ft.) each are connected to the control panel, the total distance would be 3048m (10000 ft.) which exceeds the system capacity.

Before adding any modules to the control panel make sure you shut down the AUX output by pressing and holding the AUX button for 3 seconds.

Please Note: When powering up the EVO control panel, the panel will begin a module scan to verify that all modules connected to the panel are operational. The scanning process will take between 30 seconds and 3 minutes to complete depending on the number of modules connected to the control panel. The module scan is complete when the LCD keypad begins to show the partition status. Only after the module scan is completed will the control panel be fully operational. When installing the combus wires in a noisy environment or when connecting the combus across separate buildings, you must use a shielded cable. Refer to section 2.15.1.

Please see ETL and ETLc Warnings for and information in the appendix.

Wiring methods that shall be in accordance with the National Electrical Code, ANS/NFPA 70, the Standard for Installation and Classification of Burglar and Holdup Alarm Systems, UL 681, and the Standard for Central-Station Alarm Services, UL 827.

The system should be installed in accordance with Chapter 2 of the National Fire Alarm Code, ANS/NFPA 72

The metal housing which enclosed the Fire and Burglary system housing has knockouts on the sides and in the back enclosure. The wiring method requires that bushings are used for wiring through the metal box. Including the transformer with Plug in Power Supply.

All knockouts provided for connection of a field-wiring system to a field-wiring compartment shall accommodate conduit of the trade size according to NEC.

Intended wiring methods must be in keeping with the requirements of CSA C22.1, Canadian Electrical Code, Part I, Safety Standard for Electrical Installations.

The signal transmission to the Central Station may be performed by following methods: Landline (PSTN), Internet, and GPRS. Only Internet, and GPRS method of transmission may be used for Commercial applications.

1. ETL note: Use an ETL/UL approved bell/siren
2. Wiring conventions have to be in the same room of these terminals
3. Zone Input Specifications: Maximum loop current (shorted loop): 2.2mA
4. Disconnect Telecom jack before servicing
5. The anti-tamper switch needs to be connected to a separate zone configured for 24 hrs
6. For Maximum number of devices to be employed refer to the Features in section 1.1
7. The minimum permissible wire size to be employed shall be not smaller than No. 22 AWG (0.32 mm2).

Figure 3 – EVO192 Wiring Diagram

2.9 Earth Ground

Connect the ground connector to the enclosure and to a metal cold water pipe or grounding rod as per local electrical codes.

2.10 AC Power

Use a 17Vac (50/60Hz) transformer with a minimum 20VA rating. For increased power use a 40VA rating.

AC/AC transformer:

For residential installations use transformer made by Universal Power Group model: UB1640W

For US: UL/ETL LSS standard Listed Class 2 wall/building 120VAC/60Hz power supply with restraining means.

For Canada: CSA/ULc/ETLc LSS standard Listed Class 2 Power Supply with NO restraining means

Note: Do not use any switch-controlled outlets to power the transformer. The system should be connected to the building's power source (receptacle) by an AC/AC transformer:



Do not connect the transformer or the backup battery until all wiring is completed. When powering up the EVO control panel, the panel will begin a module scan.

Do not short the terminals of the transformer together. This causes the internal fuse to blow.

The transformer must be connected to a 110 VAC, 24-hour outlet not controlled by a switch other than an approved over-current protection device.

For continued protection against risk of fire, replace fuses only with fuses of the same type and rating.

2.11 Backup Battery

Connect a 12Vdc 7Ah rechargeable acid/lead backup battery. Verify the polarity, as reversed connections will blow the battery fuse. For details on how to set the Battery Charge Current to either 350mA or 850mA, see *section 14.6* on page 89. Battery capacity for emergency standby is at least 4 hours. Using the minimum configuration of the system will provide 24 hours standby using the 7Ah battery.

2.11.1 Battery Test

1. The control panel conducts a dynamic battery test under load every 60 seconds. If the battery is disconnected, if its capacity is too low or if the battery voltage drops to 10.5 volts or less when there is no AC, the "Battery Trouble" message will appear in the Trouble Display. At 8.5 volts, the panel shuts down and all outputs close. The panel will cease to process sensor trips if the voltage is under 8.5V.

2.12 Auxiliary Power Terminals

The auxiliary power supply can power accessories in the security system. A fuseless circuit protects the auxiliary output against overload and shuts it down if the current exceeds 1.1A. Auxiliary power will resume once the overload condition has restored. Press and hold the AUX button for two seconds to turn AUX power on and off.

2.13 Bell/Siren Output

The bell output supplies 12Vdc upon alarm and can support one 30-watt or two 20-watt sirens. The bell output will automatically shut down if the current exceeds 3A. If the load on the BELL terminals returns to normal ($\leq 3A$), the control panel will re-instate power to the BELL terminals. Please verify correct polarity.

Note: Use Wheelock 46T-12 siren.



Note: For connection of self-contained bell/siren, see Figure 7 on page 22.



When the bell output is not used, the “Bell Absent” message appears in the Trouble Display. To avoid this, connect a 1k Ω resistor across the bell output. UL Note: The keypads must be programmed to beep with all troubles.

The metal housing which enclosed the Fire and Burglary system housing has knockouts on the sides and in the back enclosure and shall accommodate conduit of the trade size according to NEC.

WARNING: “To prevent risk of electric shock, disconnect AC battery and phone cord BEFORE Servicing”.

2.14 False Alarm Reduction

In an effort to deter false alarms, the EVO192 provides various programmable features, including the following programmable features:

- double knockout, cross zoning
- auto zone shutdown
- auto trouble shutdown
- intellizone
- Audible /visual entry/exit delays
- fire alarm verification
- dialer delay before an alarm transmission
- cancel report option
- exit termination zone

2.15 Programmable Outputs

PGM1 to PGM4 are 100mA (max.) solid-state relays with +/- trigger. PGM5 is a 5A/28Vdc N.O./ N.C. relay output. They can be set at either normally open or normally closed. If the current draw on PGM1 to PGM4 is to exceed the current output.

2.16 Keyswitch Connections

Connect the keyswitches to the keypad, control panel, or Zone Expansion Module's hardwired input terminals as shown in *Figure 6*.

2.17 Calculating Power Requirements

Table 1: Power Requirement Calculation

| Description | QTY. | mA used by each | Total mA |
|--|-------|-----------------|----------|
| Grafica Graphic LCD Keypads (DNE-K07): | _____ | X 130mA = | _____ mA |
| LCD Keypads (K641): | _____ | X 110mA = | _____ mA |
| LCD Keypads with Built-in Reader (K641R): | _____ | X 120mA = | _____ mA |
| LED Keypads (DGP2-648): | _____ | X 110mA = | _____ mA |
| Motion Detector Modules (DG85, DGP2-50/60/70): | _____ | X 30mA = | _____ mA |
| Door Contact Modules (DGP2-ZC1): | _____ | X 15mA = | _____ mA |
| 1-Zone Expansion Modules (DGP2-ZX1): | _____ | X 30mA = | _____ mA |
| 4-Zone Expansion Modules (APR3-ZX4): | _____ | X 30mA = | _____ mA |
| 8-Zone Expansion Modules (APR3-ZX8): | _____ | X 30mA = | _____ mA |
| Magellan Wireless Expansion Modules (MG-RTX3): | _____ | X 35mA = | _____ mA |
| 4-PGM Expansion Modules (APR3-PGM4): | _____ | X 150mA = | _____ mA |
| Printer Modules (APR-PRT3): | _____ | X 25mA = | _____ mA |
| DVACS Modules (DGP2-DVAC): | _____ | X 40mA = | _____ mA |
| Annunciator Modules (DGP2-ANC1): | _____ | X 20mA = | _____ mA |
| InTouch Voice-Assisted Arm/Disarm Modules (APR3-ADM2): | _____ | X 105mA = | _____ mA |
| Hub and Bus Isolator (APR3-HUB2): | _____ | X 50mA = | _____ mA |
| Access Control Module (DGP-ACM12): Note: The DGP-ACM12 consumes 130mA from its own power supply. The DGP-ACM11 consumes 120mA when connected on the combus for power. | _____ | X 120mA = | _____ mA |
| Listen-In Module (DGP-LSN4) | _____ | X 60mA = | _____ mA |
| Internet Module (IP100) | _____ | X 110mA = | _____ mA |
| Plug-In Voice Module (VDMP3) | _____ | X 35mA = | _____ mA |
| Other devices such as hardwired motion detectors | | | _____ mA |
| Maximum available milliamps = 700mA | | GRAND TOTAL | _____ mA |

- Using *Table 1*, calculate the total number of milliamps (mA) required by each device, module, and accessory in the system. Please take into account devices connected to the control panel's PGM outputs. Since the BELL output has its own power supply, do not include the sirens connected to it in the calculation.
- If Grand Total is less than 700mA, go to step 3. If the value is greater, an external power supply is required to provide the additional power needed. Proceed with step 3 .
- Due to the degradation of a power signal over long distances, **EACH** length or run of wire in the system can support only a specific number of milliamps (mA). Using *Table 2*, determine how many milliamps each length of wire can support. Please note that the total number of milliamps (mA) can never surpass 700mA.

Table 2: Milliamps (mA) Limitations For Each Run of Wire

| Gauge: 18AWG, Surface: 0.823mm² | |
|---|---------------------------------|
| Length of each run of wire | Available milliamps (mA) |
| 30m(100ft.) | 700 |
| 61m(200ft.) | 700 |
| 91m(300ft.) | 700 |
| 122m(400ft.) | 700 |
| 152m(500ft.) | 690 |
| 183m(600ft.) | 575 |
| 213m(700ft.) | 493 |
| 244m(800ft.) | 431 |
| 274m(900ft.) | 383 |
| 305m(1000ft.) | 345 |
| 457m(1500ft.) | 230 |
| 610m(2000ft.) | 172 |
| 762m(2500ft.) | 138 |
| 914m(3000ft.) | 115 |

| Gauge: 22AWG, Surface: 0.326mm² | |
|---|---------------------------------|
| Length of each run of wire | Available milliamps (mA) |
| 30m(100ft.) | 700 |
| 61m(200ft.) | 682 |
| 91m(300ft.) | 454 |
| 122m(400ft.) | 341 |
| 152m(500ft.) | 273 |
| 183m(600ft.) | 227 |
| 213m(700ft.) | 195 |
| 244m(800ft.) | 170 |
| 274m(900ft.) | 151 |
| 305m(1000ft.) | 136 |
| | |
| | |
| | |
| | |
| | |

| Gauge: 24AWG, Surface: 0.205mm² | |
|---|---------------------------------|
| Length of each run of wire | Available milliamps (mA) |
| 30m(100ft.) | 700 |
| 61m(200ft.) | 429 |
| 91m(300ft.) | 286 |
| 122m(400ft.) | 214 |
| 152m(500ft.) | 171 |
| 183m(600ft.) | 143 |
| | |
| | |
| | |
| | |
| | |
| | |
| | |

Note: The minimum permissible wire size to be employed shall be not smaller than No. 22 AWG (0.32 mm²).

Figure 4 – Sample Power Requirement Calculations
 Power required by devices connected to control panel's

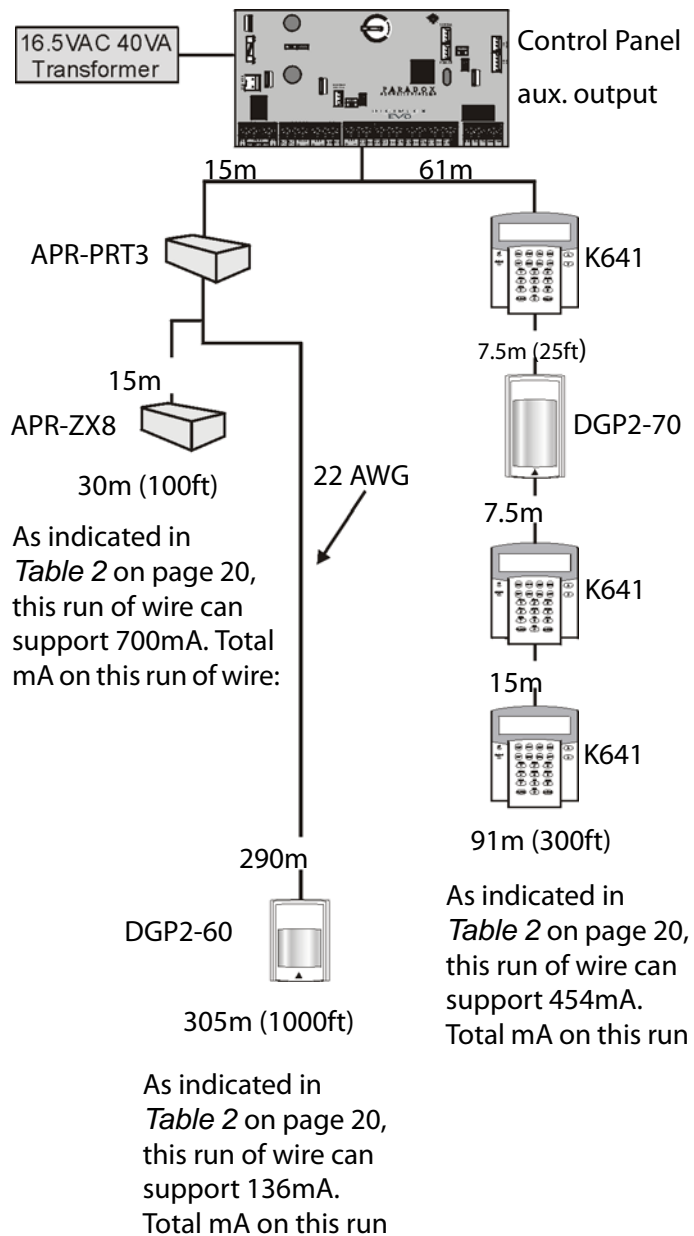

⚠ Do not use the same transformer for the control panel and the external power supplies. Do not install modules more than 914m (3000ft) from the control panel.

2.18 Keypad Zone Connections

Every keypad, except Grafica, has one hardwire input terminal.

⚠ Even with the ATZ feature enabled in the control panel, only one device can be connected to the keypad's hardwired input terminal. Tamper is not recognized on keypad zones. The keypad zone follows the control panel's EOL definition.

The keypad communicates the status of the zone to the control panel via the combus.

Figure 5: External Power Supply Connections

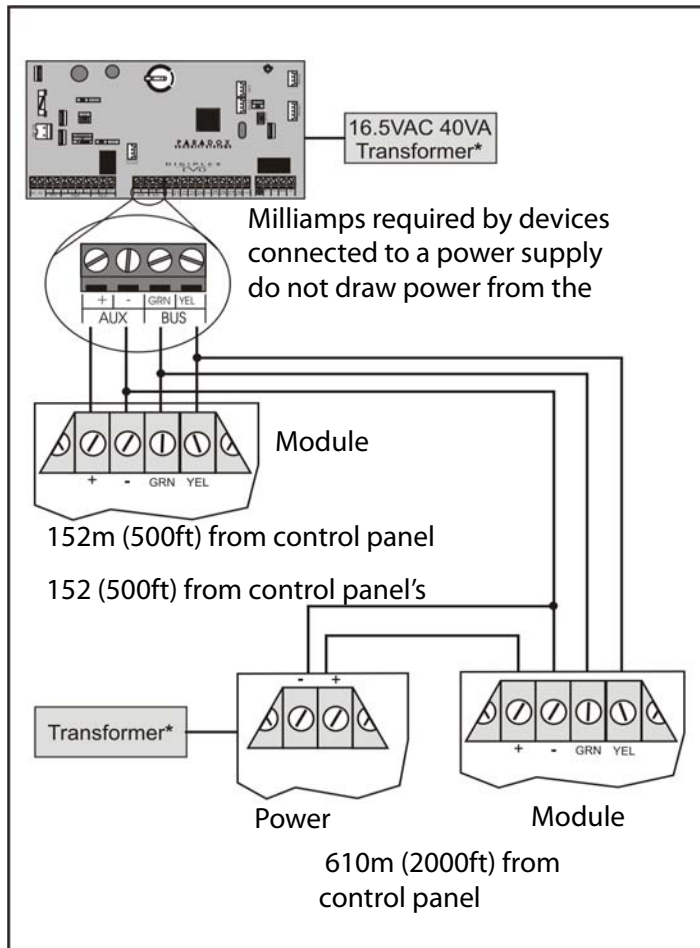

2.19 Addressable Zone Connections

The control panel includes eight hardwired input terminals for use with traditional hardwired (non-combus) door contacts, smoke detectors and/or motion detectors.

The control panel also supports hardwire zone expansion modules. *Figure 6* shows single zone (ATZ disabled) hardwire input terminal connections recognized by the Digiplex EVO system. For UL listed installations, use EOL resistor part #2011002000.

Figure 6: Single Zone Input Connections

N.C. Contacts, No EOL

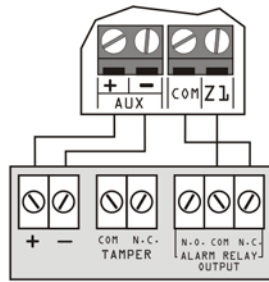

Detector Terminals

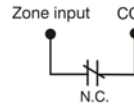

**N.C., With EOL
UI/ULC Configuration
CONTROL PANEL TERMINAL**

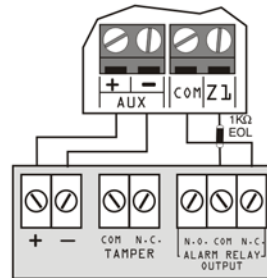

Detector Terminals *Normally Closed*

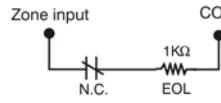

**N.O., With EOL
UI/ULC Configuration
CONTROL PANEL TERMINAL**

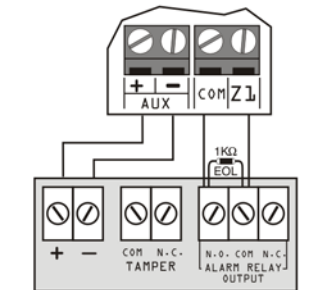

Detector Terminals *Normally Open*

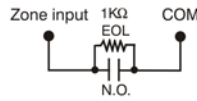

**N.C. Contacts, No EOL,
With tamper recognition
CONTROL PANEL TERMINAL**

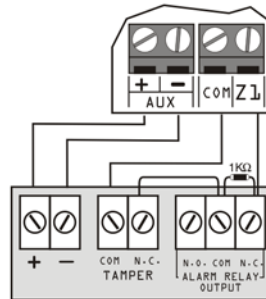

Detector Terminals

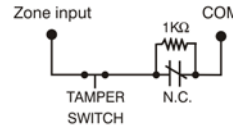

**N.C. With EOL, With Tamper
& Wire Fault Recognition
UL/ULC Configuration
CONTROL PANEL TERMINAL**

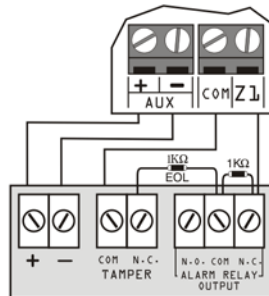

Detector Terminals

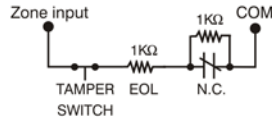

**N.O., With EOL, With Tamper
& Wire Fault Recognition†
CONTROL PANEL TERMINAL**

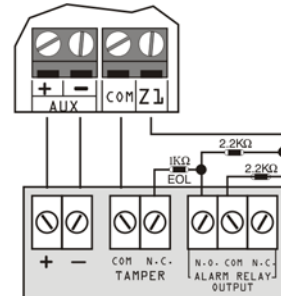

Detector Terminals

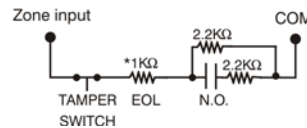

† Enable ATZ (section 4.3 on page 33) and connect as follows (extra input cannot be used)

2.20 Double Zone Connections

Enabling the ATZ feature (see *section 4.3*) allows you to install two detection devices per input terminal. Connect the devices as shown in *Figure 7*. For UL listed Burglary System installations only, use EOL resistor part #2011002000.

Figure 7: Double Zone Connections

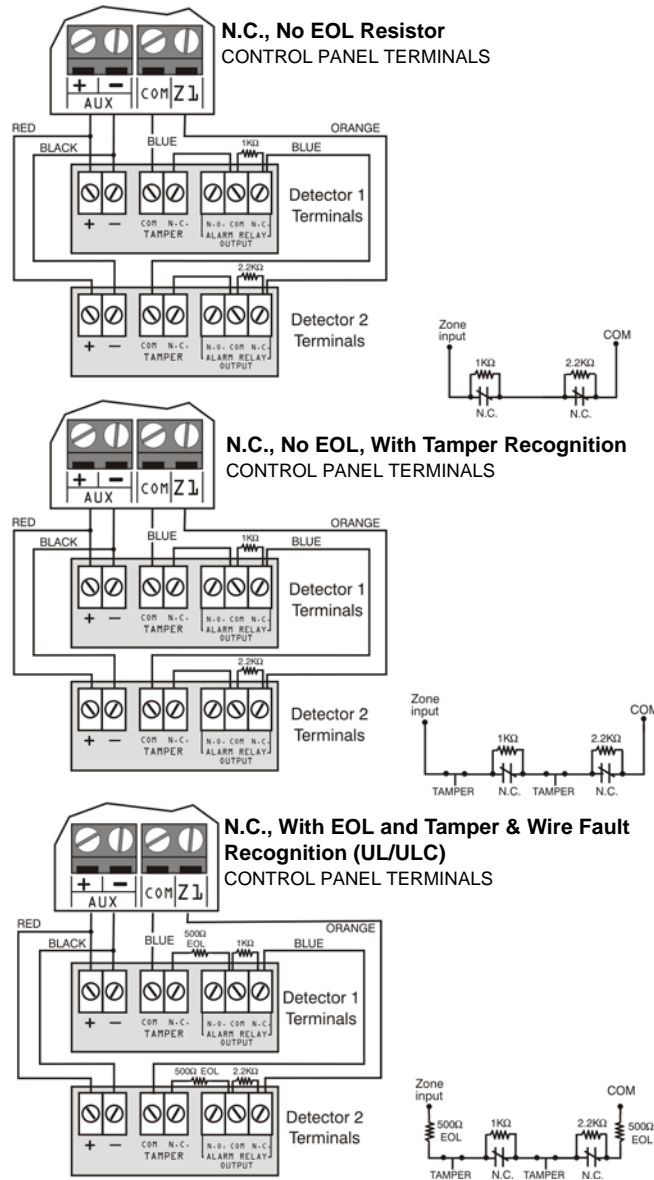

2.21 Combos Connections

The 4-wire combus can support 127 (EVO48) or 254 (EVO192) modules. Use star and/or daisy chain configuration. The total length of wire cannot exceed 914m (3000ft).



Before connecting a module to the combus, remove AC and battery power from the control panel.

2.21.1 Connecting the Combus in Noisy Environments

When installing the combus wires in proximity to high electrical interferences or across separate buildings, use shielded cables:

Within the Same Building: Strip the outer jacket at one end of the shielded cable to expose the shield and connect the shield to the control panel ground (not the dialer ground), while leaving the shield at the other end of the cable open (floating).

Across Separate Buildings: Strip the outer jacket at one end of the shielded cable to expose the shield. In the same building as the control panel, connect the exposed shield to any earth ground available, while leaving the shield at the other end of the cable open (floating). The same configuration applies for any subsequent building.

2.22 Fire Circuits

Assign the smoke detectors connected to the control panel or zone expansion input terminals to a zone and define the zone's parameters as a Fire Zone (see section 4.4.12 and see section 4.4.13 on page 35).

2.22.1 Smoke Detector Installation (2-Wire)*

PGM1 can be defined as a 2-wire smoke detector input (see). Connect the 2-wire smoke detectors as shown in *Figure 8*. If a line short occurs or the smoke detector activates, whether the system is armed or disarmed, the control panel will generate an alarm. If the line is open, the "Zone Fault" trouble indication appears in the Trouble Display and the report code is sent to the monitoring station, if programmed.

**UL Note: Not to be used with UL Listed systems.*

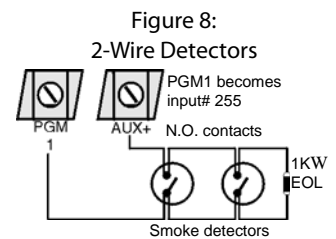

Note: It is recommended that the smoke detectors be connected in a daisy chain configuration.

2.22.2 ESL CleanMe® Installation

Connect ESL smoke detectors like the standard smoke detectors. Avoid connecting more than 20 ESL smoke detectors. When a CleanMe signal is sent, the control panel will generate a Zone Fault trouble and may transmit the Fire Loop report code to the monitoring station. The trouble will be cleared if there is no CleanMe signal for 255 seconds. If an alarm occurs, the trouble will be cleared until it is detected again.

2.22.3 Smoke Detector Installation (4-Wire)

Recommended: System Sensor model 2112/24D smoke detectors. Connect the 4-wire smoke detectors and a relay as shown in *Figure 9*. To comply with UL955, install the 4-wire smoke detectors with 18 gauge wire. If power is interrupted, the relay causes the control panel to transmit the Fire Loop Trouble report programmed in section [2906].

To reset (unlatch), connect the smoke detector's negative (-) to a PGM. Then program the PGM with the "Smoke Detector Power Reset" activation event (; Event Group #067, start # 004, end # 004) to interrupt power to the smoke detector for four seconds when the [CLEAR] and [ENTER] keys are pressed and held for two seconds.

In order to enable "Fire Alarm Verification" go to section [3028] and set option [4] to Enable.

Note: The 2-wire smoke detector is not UL approved.

Figure 9: 4-Wire Detectors

Fire Zones
UL/ULC Installation
Control Panel Terminals

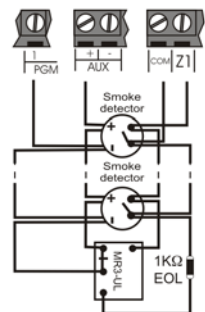

Note: It is recommended that the smoke detectors be connected in a daisy chain configuration.

⚠ If ATZ is enabled (section 4.3 on page 33), do not use the extra input (doubled zone).

Figure 10: Telephone Line Connection Examples

Example 1:

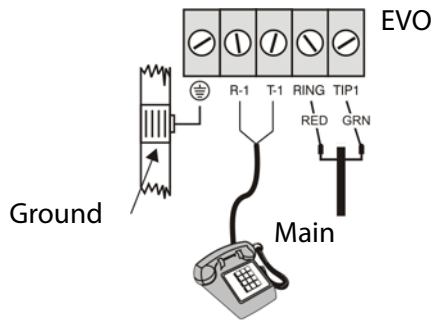

Example

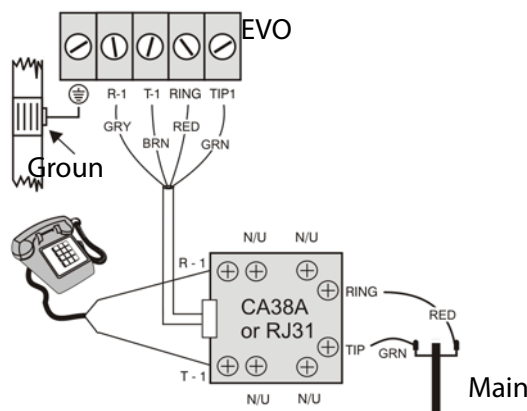

2.23 Telephone Line Connections

Section 4.5 requires a programmable option for call waiting cancel shall be required on communicators that use media (e.g. PSTN) where call-waiting may be provisioned.

The programming for this feature must be added to the Programming Guide.

The installer needs to verify the code in the premises area for the telephone network that disables the call waiting feature, then add it to the monitoring station number.

For example:

Receiving center phone number: 999-999-999

Call waiting cancellation code: *70

Phone number to program: *70P999999999

) Instructions that an automatic telephone dialer or similar device shall not be set or programmed to place a call to a police station number that has not been specifically assigned by that police station for such service. The instructions may be incorporated on the inside of the product, on a separate sheet, or as part of a manual. If not included directly on the product, the instructions or manual shall be referenced in the marking information on the product. .

Note: Do NOT program this system or any of its modules to automatically place a call to a police station number that has not been specifically assigned by that police station for such a service.

The installation instructions shall state that the communication medium between protected property and communications service provider shall be for the exclusive use of the protected property and is not to be shared with other communications service provider subscribers

Note: The phone line between the protected property and the communications service provider shall be for the exclusive use of the protected property and is not to be shared with other communications service provider subscribers.

The telephone lines can be connected directly to the control panel or through a CA38A or RJ31 as shown in *Figure 10*.

Note: **UL Note** Installer must verify line seizure after every installation

For TBR-21 compliance, please note the following:

1. The EVO can be connected to the telephone network via an RJ-11 connector.
2. The Maximum Dialing Attempts cannot exceed 15 attempts.

2.24 Built-in RTC

The RTC will save the EVO's internal clock when both the AC and battery power have been lost. The RTC uses a 3V lithium battery (CR2032) with a battery life of 11 years. Change the battery as shown below:

3V Lithium
Battery
Insert the battery
with the positive
facing up and the



Figure 11: Changing the RTC's Battery



Reprogram the control panel's clock after changing the battery.

Danger of explosion exists if the lithium battery is incorrectly replaced. Replace only with the same or equivalent type recommended by the manufacturer. Dispose of used batteries according to the manufacturer's instructions.

3.1 Paradox Memory Key

The Paradox Memory Key can copy the programmed contents of one control panel into as many others.

Note: Not to be used with UL Listed systems.

Copy to Memory Key

1. Insert the Memory Key (PMC-4) onto the control panel's connector labelled "MEM KEY".
2. To copy the contents to the Memory Key **except** zone numbering and sections [0501] to [0532], enter installer programming mode, then enter section [4020]. (Depending on the memory key, the labels may or may not be included.)
To copy the contents to the Memory Key **including** zone numbering and sections [0501] to [0532], enter section [4021]. (Depending on the memory key, the labels may or may not be included.)
3. When the keypad emits a confirmation beep, remove the Memory Key. Remove the write protect jumper.

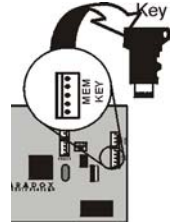

Download to Control Panel

1. Insert the Memory Key onto the control panel's connector labelled "MEM KEY".
2. To download the contents of the *Memory Key* **except** zone numbering and sections [0501] to [0532], enter installer programming mode and then enter section [4010]. (Depending on the memory key, the labels may or may not be included.)
To download the contents of the Memory Key **including** zone numbering and sections [0501] to [0532], enter installer programming mode and then enter section [4011]. (Depending on the memory key, the labels may or may not be included.)
3. When the keypad emits a confirmation beep, remove the Memory Key.

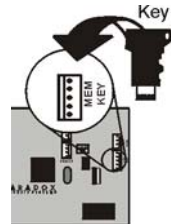
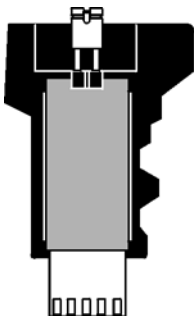

Figure 12: Using the Memory Key

Jumper ON =

Can copy and



Jumper OFF =

Cannot override

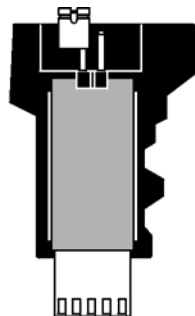

3.2 Module Broadcast

Keypads and other modules can also be programmed easily by using Module Broadcast. Once a module is programmed, its sections can be sent to other similar modules through the combus.

3.3 Programming Through BabyWare

It is recommended that system and module programming be done through BabyWare.

3.4 Programming Through a Keypad

Use the “EVO Programming Guide” to record how the sections were programmed. To enter programming mode:

1. Press and hold the [0] key.
2. Key in the [INSTALLER CODE] (default = **000000**).
3. Key in the 4-digit [SECTION].
4. Key in required [DATA]. Refer to the “EVO Programming Guide” or to the corresponding sections in this manual.

For LCD Keypads: The control panel will save the data and go to the next section or press the [ENTER] key to save the data and go to the next section. Press the [CLEAR] key go to the preceding step or to erase the current data entry.

For Grafica Keypads: Press Grafica’s center action key (**Save**) to save the data and go to the next section. Press the right action key (**Exit**) to go to the preceding step or press the left action key (**Clear**) to erase the current data.

3.4.1 Feature Select Programming

Most of the options are programmed using the Feature Select Method.

For LCD Keypads: The option is considered ON when the number appears within the brackets on the LCD keypad. Turn options ON and OFF by pressing the corresponding keys on the keypad and then press [ENTER] to save.

For Grafica Keypads: Select or clear the check boxes or set the options by pressing the corresponding keys on the keypad. The feature is considered ON when its check box is selected. Press the Grafica’s center action key (**Save**) to save.

3.4.2 Decimal Programming

Sections may require 3-digit decimal values from 000 to 255.

3.4.3 Hexadecimal Programming

Sections may require Hexadecimal values from 0 to F. Press:

For LCD Keypads:

- | | | | |
|-------------|------------------------------|--------------|-----|
| [0] to [9] | = values 0 to 9 respectively | | |
| [STAY] key | = A | [DISARM] key | = D |
| [FORCE] key | = B | [BYP] key | = E |
| [ARM] key | = C | [MEM] key | = F |

For Grafica Keypads:

- | | |
|------------|---|
| [0] to [9] | = values 0 to 9 respectively |
| [#] | = A to F (press the key until the desired letter appears) |

3.5 Module Programming Mode

To program a Module with a keypad, enter Module Programming Mode:

1. Press and hold the [0] key.
2. Key in the [INSTALLER CODE] (default = **000000**).
3. Key in section [4003].
4. Key in 8-digit [SERIAL NUMBER] of the module.
5. Key in 3-digit [SECTION] and required [DATA]. Refer to the "Module Programming Guide" for details.

The control panel will redirect all programming to the selected module. To exit the Module Programming Mode, press the [CLEAR] key on LCD keypads, or the right action key (**Exit**) on Grafica keypads.

Zone Programming

Enter Section [0400], then enter the

! In any Zone Programming option, pressing [ACC] will save the data and go to the next zone on the same option

Enter the zone's 8-digit serial and 3-digit input number (The input number is not

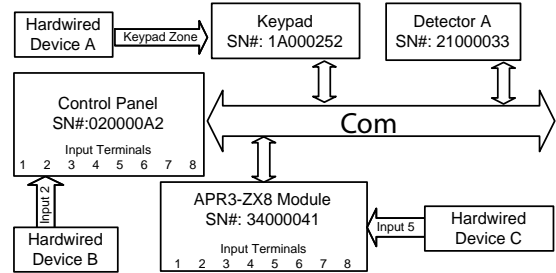

| | Zone# | Section# | Serial# | Input# |
|---------------------|-------|----------|----------|--------|
| Detector A: | 1 = | [0001] | 21000033 | N/A |
| Hardwired Device A: | 2 = | [0002] | 1A000252 | N/A |
| Hardwired Device B: | 3 = | [0003] | 020000A2 | 002 |
| Hardwired Device C: | 4 = | [0004] | 34000041 | 005 |

Enter the zone's parameters

| Zone Definition | Partition | Zone Option |
|-------------------------------|--|---------------------------------------|
| _____ | _____ | 1 2 3 4 5 6 7 8 |
| 0 - Disabled (default) | 1 - Assigned to Partition 1 (default) | [1] Auto Zone Shutdown Enabled |
| 1 - Entry Delay 1 | 2 - Assigned to Partition 2 | [2] Bypass Enabled (default) |
| 2 - Entry Delay 2 | 3 - Assigned to Partition 3 | [3] Stay Zone |
| 3 - Follow | 4 - Assigned to Partition 4 | [4] Force Zone |
| 4 - Instant | 5 - Assigned to Partition 5 | [5] [6] Zone Alarm Type |
| 5 - 24Hr Buzzer | 6 - Assigned to Partition 6 | off off Steady Alarm |
| 6 - 24Hr Burglary | 7 - Assigned to Partition 7 | off on Pulsed Alarm |
| 7 - 24Hr Hold-up | 8 - Assigned to Partition 8 | on off Silent Alarm |
| 8 - 24Hr Gas | | on on Report Only |
| 9 - 24Hr Heat | | [7] Intellizone |
| A - 24Hr Water | | [8] Delay before Transmission |
| B - 24Hr Freeze | | |
| C - Delayed 24Hr Fire | | |
| D - Standard 24Hr Fire | | |
| E - Stay Delay 1 | | |
| F - Stay Delay 2 | | |

Enter the zone's report codes

| Alarm Report Code | Alarm Restore Report Code | Tamper Report Code | Tamper Restore Report Code |
|-------------------|---------------------------|--------------------|----------------------------|
| __ / __ | __ / __ | __ / __ | __ / __ |

Enter the zone's label

Ademco slow, Silent Knight fast, SESCOA, Ademco express or Pager formats:
Key-in desired 2-digit hex values from 00 to FF.

Ademco format:
Use section [4032] to program a set of default Ademco report codes from the *Auto Report Code Programming* on page 77. Then to program the remaining report codes or to change some

Press [ENTER] to save and go to the next

Pressing [CLEAR] twice will exit the zone programming

4.1 Zone Programming

Two different methods can be used to program zones:

4.1.1 Using section [0400]

Allows you to program zones 001 through 192 as shown in the diagram.



In any Zone Programming option, pressing [ACC] will save the data and go to the next zone on the same option screen. Pressing [TRBL] will save the data and go to the previous zone on the same option screen.

4.1.2 Using zone serial and input numbers

If you are not using an K641 or an K641R keypad, you can only program zones 1 to 96 through sections **[0001]** to **[0096]**.

| Zone Number | Zone Numbering | Zone definitions | Zone Partition Assignment | Zone Options |
|-------------|----------------|------------------|---------------------------|--------------|
| 1 | [0001] | [0101] | [0201] | [0301] |
| 2 | [0002] | [0102] | [0202] | [0302] |
| | +1 per zone | +1 per zone | +1 per zone | +1 per zone |
| 96 | [0096] | [0196] | [0296] | [0396] |

4.2 Zone Numbering

SECTION [0400]

SECTIONS [0001] to [0096]

- To assign an addressable PIR or door contact to the combus, program the module's serial number into the section corresponding to the zone.
- To assign a detection device connected to a module or control panel's hardwired input terminal, program the module's or control panel's serial number and the input number to the desired zone. See the "Digiplex Modules Programming Guide" for details of its input numbers (input numbers not required for keypad zones).



If PGM1 is defined as a smoke detector input, the control panel will recognize it as input # 255.

4.2.1 Clearing a Zone's Numbering

Using section [0400]

1. Enter the zone number you wish to delete.
2. Press **[0]** all the way through the serial/input, parameters and report codes screen.
3. Press **[ENTER]** to exit.

Using an LCD Keypad:

1. Enter a section number between **[0001]** to **[0096]**.
2. Press **[0]** and then **[ENTER]** to save and exit.

Using a Grafica Keypad:

1. Enter a section number between **[0001]** to **[0096]**.
2. Press **[0]** to clear the serial number.
3. Highlight the input number and then press **[0]** to clear the data.

4. Press Grafica's center action key (**Save**) to save and exit.

4.3 Zone Doubling (ATZ)

SECTION [3033]: OPTION [8]

(default = **disabled**) Fire Zones cannot be doubled.

| Input | Doubled Zone Input |
|----------|----------------------------|
| Input 01 | Input 09 (ATZ of Input 01) |
| Input 02 | Input 10 (ATZ of Input 02) |
| Input 03 | Input 11 (ATZ of Input 03) |
| Input 04 | Input 12 (ATZ of Input 04) |
| Input 05 | Input 13 (ATZ of Input 05) |
| Input 06 | Input 14 (ATZ of Input 06) |
| Input 07 | Input 15 (ATZ of Input 07) |
| Input 08 | Input 16 (ATZ of Input 08) |

4.4 Zone Definitions

4.4.1 Zone Disabled

section [0400]: First digit = 0

SECTIONS [0101] TO [0196]: FIRST DIGIT = 0

Disables the corresponding zone. Zones are disabled by default.

4.4.2 Entry Delays 1 and 2

section [0400]: First digit = 1 and 2

SECTIONS [0101] TO [0196]: FIRST DIGIT = 1 AND 2

(default Entry Delay 1 = **030**, Entry Delay 2 = **060**) A zone defined as Entry Delay 1 follows the Entry Delay 1 Timer of its assigned partition. A zone defined as Entry Delay 2 follows the Entry Delay 2 Timer of its assigned partition. Each partition includes two Entry Delay Timers. To program an Entry Delay Timer, key in the desired 3-digit delay value (001 to 255 seconds) into the corresponding section.

| | |
|--|--|
| Partition 1 Entry Delay 1 Timer: [3111] Entry Delay 2 Timer: [3112] | Partition 2 Entry Delay 1 Timer: [3211] Entry Delay 2 Timer: [3212] |
| Partition 3 Entry Delay 1 Timer: [3311] Entry Delay 2 Timer: [3312] | Partition 4 Entry Delay 1 Timer: [3411] Entry Delay 2 Timer: [3412] |
| Partition 5 Entry Delay 1 Timer: [3511] Entry Delay 2 Timer: [3512] | Partition 6 Entry Delay 1 Timer: [3611] Entry Delay 2 Timer: [3612] |
| Partition 7 Entry Delay 1 Timer: [3711] Entry Delay 2 Timer: [3712] | Partition 8 Entry Delay 1 Timer: [3811] Entry Delay 2 Timer: [3812] |



These are the same timers used for Stay Delay zones.

4.4.3 Follow Zones

section [0400]: First digit = 3

SECTIONS [0101] TO [0196]: FIRST DIGIT = 3

The control panel waits until the end of the Entry Delay before generating an alarm if an Entry Delay zone opens before the Follow zone.

4.4.4 Instant Zones

SECTION [0400]: FIRST DIGIT = 4

SECTIONS [0101] TO [0196]: FIRST DIGIT = 4

When an armed Instant zone opens, the control panel immediately generates an alarm.

4.4.5 24Hr Buzzer Zones

SECTION [0400]: FIRST DIGIT = 5

SECTIONS [0101] TO [0196]: FIRST DIGIT = 5

Whenever a 24Hr Buzzer zone opens, the control panel activates the keypad buzzer to indicate that the zone was breached. The control panel will report the alarm, but will not enable the bell/siren output. Enter any valid access code on the keypad to stop the buzzer.



The keypads must be assigned to the same partition as the 24Hr Buzzer zone or the buzzer will not activate. UL Note: Not to be used for perimeter protection.

4.4.6 24Hr Burglary Zones

SECTION [0400]: FIRST DIGIT = 6

SECTIONS [0101] TO [0196]: FIRST DIGIT = 6

When a 24Hr Burglary zone opens, the control panel will immediately generate a burglary alarm.

4.4.7 24Hr Hold-up Zones

SECTION [0400]: FIRST DIGIT = 7

SECTIONS [0101] TO [0196]: FIRST DIGIT = 7

When a 24Hr Hold-up zone opens, the control panel will immediately generate an alarm.



The SIA FSK reporting format includes specific codes to identify the alarm as a Hold-up, Gas, Heat, Water, or Freeze Alarm.

4.4.8 24Hr Gas Zones*

SECTION [0400]: FIRST DIGIT = 8

SECTIONS [0101] TO [0196]: FIRST DIGIT = 8

When a 24Hr Gas zone opens, the control panel will immediately generate an alarm.

4.4.9 24Hr Heat Zones**

SECTION [0400]: FIRST DIGIT = 9

SECTIONS [0101] TO [0196]: FIRST DIGIT = 9

When a 24Hr Heat zone opens, the control panel will immediately generate an alarm.

**** UL Note:** UL Listed compatible devices must be used for UL systems. For UL Listed systems, this type of zone should be programmed as a pulsing Fire alarm.

4.4.10 24Hr Water Zones*

SECTION [0400]: FIRST DIGIT = A

SECTIONS [0101] TO [0196]: FIRST DIGIT = A

When a 24Hr Water zone opens, the control panel will immediately generate an alarm.

4.4.11 24Hr Freeze Zones*

SECTION [0400]: FIRST DIGIT = B

SECTIONS [0101] TO [0196]: FIRST DIGIT = B

When a 24Hr Freeze zone opens, the control panel will immediately generate an alarm.

*** UL Note:** UL Listed compatible devices must be used for UL systems. For UL Listed systems, this type of zone must be programmed as a silent auxiliary alarm.

4.4.12 Delayed 24Hr Fire Zone (Not to be used with UL Listed systems)

SECTION [0400]: FIRST DIGIT = C

SECTIONS [0101] TO [0196]: FIRST DIGIT = C

The Delayed 24Hr Fire Zone definition from *Figure 14* on page 38 is used in homes where a smoke detector often generates false alarms. A zone programmed as Fire becomes normally open and requires an EOL resistor.



The keypads must be assigned to the same partition as the Delayed 24Hr Fire zone for the buzzer to activate.

*** UL Warning: For UL/ULC installations, a Fire zone cannot be bypassed and its alarm type must be Pulsed (audible).**

4.4.13 Standard 24Hr Fire Zone

SECTION [0400]: FIRST DIGIT = D

SECTIONS [0101] TO [0196]: FIRST DIGIT = D

A zone programmed as Fire becomes normally open and requires an EOL resistor. When a Standard 24Hr Fire Zone triggers, the control panel can:

- send a Zone Alarm report code.
- send a Fire Loop Trouble Report if a tamper/wiring fault occurs on a Fire Zone. A “Zone Fault Trouble” will also appear in the keypad's Trouble Display.
- generate a Fire alarm, which can be silent, pulsed, steady or report only. Fire alarms generate an intermittent signal (see *Figure 13*).
- Need to instruct how to install the Tamper – set it to 24hr Zone

Note: Set the tamper to a 24hr Zone

*** UL Warning: For UL/ULC installations, a Fire Zone cannot be bypassed and its alarm type must be Pulsed (audible).**

Figure 13: Bell/Siren Output During Fire Alarm

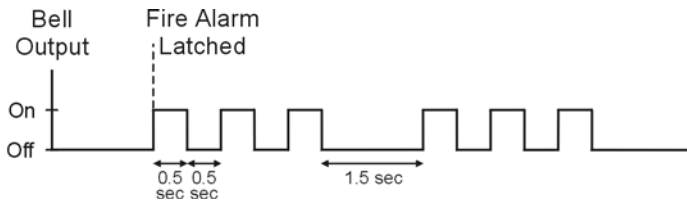

4.4.14 Stay Delay Zone

SECTION [0400]: FIRST DIGIT = E AND F

SECTIONS [0101] TO [0196]: FIRST DIGIT = E AND F

Using the Regular or Force arming methods, the control panel processes the zone as an Instant zone. Using the Stay or Instant arming methods and the zone is triggered, the control panel will not generate an alarm until the programmed Stay Delay elapses. A zone defined as Stay Delay 1 follows the Entry Delay 1 Timer of its assigned partition. A zone defined as Stay Delay 2 follows the Entry Delay 2. To program the Entry Delay Timers.

4.5 Zone Partition Assignment

SECTION [0400]: SECOND DIGIT = 1 TO 8

SECTIONS [0101] TO [0196]: SECOND DIGIT = 1 TO 8

Assign zones to one partition.

4.6 Zone Options

The zone options from are described below. Refer to the EVO programming guide for additional information on Zone Programming.

4.6.1 Auto Zone Shutdown

SECTION [0400]: OPTION [1]

SECTIONS [0101] TO [0196]: OPTION [1]

(default = **000**) When enabled, the control panel will stop generating alarms once the Auto Zone Shutdown Limit is reached. It resets every time the partition that is assigned to the corresponding zone is armed. To program the Auto Zone Shutdown Limit, enter the desired 3-digit counter (000 to 015) into section corresponding to the desired partition (000 = disabled):

| | |
|----------------------------|----------------------------|
| Partition 1: [3114] | Partition 5: [3514] |
| Partition 2: [3214] | Partition 6: [3614] |
| Partition 3: [3314] | Partition 7: [3714] |
| Partition 4: [3414] | Partition 8: [3814] |

4.6.2 Bypass Zones

SECTION [0400]: OPTION [2]

SECTIONS [0101] TO [0196]: OPTION [2]

(default = **enabled**) Allow zones to be Manually Bypassed.

4.6.3 Stay Zones

SECTION [0400]: OPTION [3]

SECTIONS [0101] TO [0196]: OPTION [3]

Only zones with option [3] enabled will be bypassed when the partition is Stay armed or Instant armed. All other zones will remain activated. Fire Zones cannot be set as Stay Zones.

4.6.4 Force Zones (Not to be used with UL Listed systems)

SECTION [0400]: OPTION [4]

SECTIONS [0101] TO [0196]: OPTION [4]

Only zones with option [4] enabled can be bypassed when the partition is Force armed. Fire Zones cannot be Force Zones.

4.6.5 Alarm Types

SECTION [0400]: OPTION [2] & [6]

SECTIONS [0101] TO [0196]: OPTIONS [5] & [6]

| Option | | Feature | Description |
|------------|------------|--------------|--|
| [5] | [6] | | |
| OFF | OFF | Steady Alarm | sends the report code and activates the bell output |
| ON | OFF | Pulsed Alarm | sends the report code and pulses the bell output (see <i>Figure 14</i>) |
| OFF | ON | Silent Alarm | sends the report code, but the bell output is not activated. Partition must be disarmed. |
| ON | ON | Report Only | sends the report code. Disarming is not required. |

4.6.6 Intellizone*

SECTION [0400]: OPTION [7]

SECTIONS [0101] TO [0196]: OPTION [7]

(default = **032**) If an alarm condition occurs on a zone with option [7] enabled, the control panel triggers the Intellizone Delay. Fire Zones cannot be set as Intellizones. An alarm will only be generated if the selected conditions occur during the Intellizone Delay:

1. An alarm occurs on another zone defined as Intellizone.
2. The zone in alarm restores and reoccurs.
3. The zone stays in alarm for the entire Intellizone Delay.

Key in the desired 3-digit delay value (010 to 255 seconds, default value is 32 seconds) into the section corresponding to the desired partition



Any value less than 10 seconds will be replaced by the default value of 32 seconds.

| | | | |
|---------------------|---------------------|---------------------|---------------------|
| Partition 1: [3110] | Partition 3: [3310] | Partition 5: [3510] | Partition 7: [3710] |
| Partition 2: [3210] | Partition 4: [3410] | Partition 6: [3610] | Partition 8: [3810] |

* **UL Note:** For UL Listed systems, the detection pattern of both zones must be installed so that each zone has the capability of protecting the area alone.

4.6.7 Intellizone Options

Use these options to enable or disable different Intellizone related options.

| | | | |
|---------------------|---------------------|---------------------|---------------------|
| Partition 1: [3126] | Partition 3: [3326] | Partition 5: [3526] | Partition 7: [3726] |
| Partition 2: [3226] | Partition 4: [3426] | Partition 6: [3626] | Partition 8: [3826] |

| Option | Description |
|--------|---|
| [1] | Intellizone Delay (default = disabled) The zone stays in alarm for the entire Intellizone Delay. |
| [2] | Intellizone Double Knockout and Zone Crossing (default = disabled) The zone in alarm restores and reoccurs or an alarm occurs on another zone defined as Intellizone |
| [3] | Intellizone Zone Crossing (default = disabled) An alarm occurs on another zone defined as Intellizone. |
| [5] | Police Code is Generated on Zone Crossing Only (default = disabled) |

Figure 14: Delayed 24Hr Fire Zone

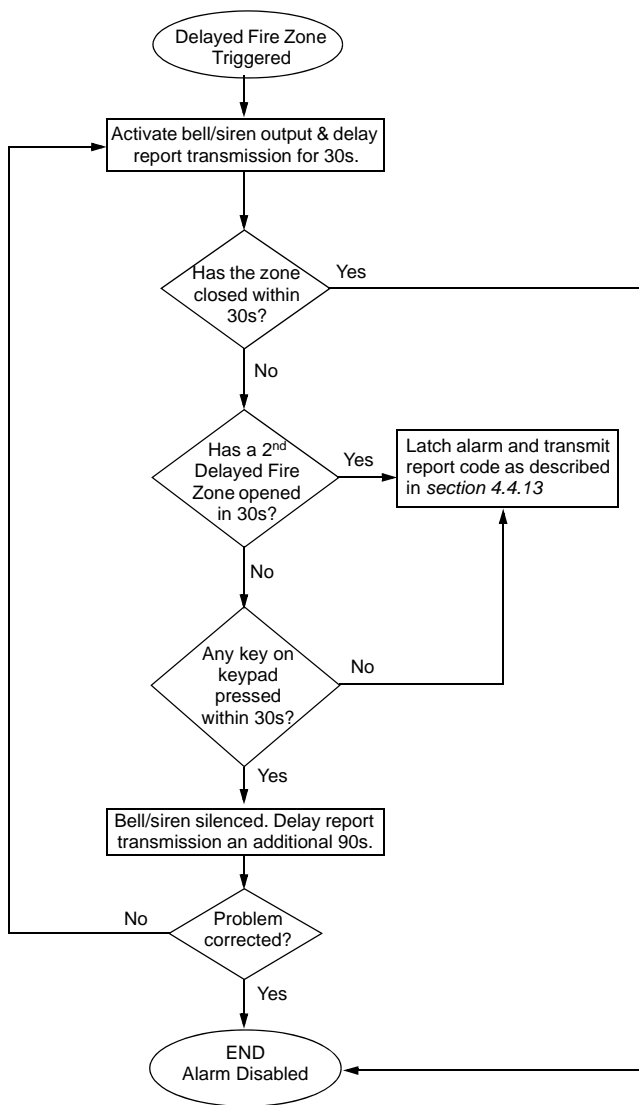

4.6.8 Delay Before Alarm Transmission

SECTION [0400]: OPTION [8]

SECTIONS [0101] TO [0196]: OPTION [8]

(default = **000**) When an alarm condition occurs on a zone with option [8] enabled, the alarm will not be reported to the monitoring station until the end of the Alarm Transmission Delay. Disarming the system cancels any report originating from this zone. To program the Alarm Transmission Delay, access section [3055].

4.7 Input Speed

(001 to 255 X 30msec, default = **600ms**)

The Input Speed defines how quickly the control panel responds to an open zone detected on any hardwired input terminal (does not apply to addressable motion detectors and door contacts). Set the Input Speed (001 to 255 X 30ms, default = **600ms**):

| | | | |
|--------|----------|--------|----------------------------|
| [0961] | Input 01 | [0973] | Input 13 (ATZ of Input 01) |
| [0962] | Input 02 | [0974] | Input 14 (ATZ of Input 02) |
| [0963] | Input 03 | [0975] | Input 15 (ATZ of Input 03) |
| [0964] | Input 04 | [0976] | Input 16 (ATZ of Input 04) |
| [0965] | Input 05 | [0977] | Input 13 (ATZ of Input 01) |
| [0966] | Input 06 | [0978] | Input 14 (ATZ of Input 02) |
| [0967] | Input 07 | [0979] | Input 15 (ATZ of Input 03) |
| [0968] | Input 08 | [0980] | Input 16 (ATZ of Input 04) |

4.8 EOL on Hardwire Zones

SECTION [3033]: OPTION [7]

(default = **disabled**) If detection devices connected to hardwired input terminals use 1kΩ end of line resistors, enable option [7] in section [3033]. For details on using EOL resistors, refer to "Addressable Zone Connections" 2.19 and *Double Zone Connections* on page 24.

4.9 Keypad Numbering

SECTIONS [2801] TO [2832]

Keypad Numbering identifies the keypad in the event buffer. The keypad is assigned to a Keypad Number from 1 to 32 through the keypad's serial number in sections [2801] to [2832].

5.1 Hardware Requirements

If the EVO48 System Includes:

MG-RTX3 Wireless Expansion Module And K641 / K641R keypad
 Up to 96 remote controls can now be programmed into the EVO control panel and configured using a master code or installer code.

If the EVO192 System Includes:

MG-RTX3 Wireless Expansion Module And K641 / K641R keypad
 Up to 999 remote controls can now be programmed into the EVO control panel and configured using a master code or installer code.

If the System Includes:

MG-RTX3 Wireless Expansion Module But does not include:K641 / K641R keypad. Remote controls must be stored in the wireless expansion module (32 remotes per MG-RTX3) by enabling option [1] in section [3029].

5.2 Remote Control Template

It is possible to set up to 16 different button templates which can then be assigned to individual users. Each user is pre-programmed with a default remote control button pattern: (1 B) (C 0) (template 1).

| Section | Option | Description |
|---------|-------------------------|---|
| [2940] | Default button Template | To select a button template as the default template, enter (00) to (15) representing button templates in sections [2900] to [2915]. |
| [2941] | Assign Button Template | To assign a button template to a user, select user when prompted, then enter (00) to (15) representing button templates in sections [2900] to [2915]. |

| Section | Template# | Button | Options |
|---------|------------|---------|---------|
| [2900] | Template 1 | (_/_) | (_/_) |
| [2901] | Template 2 | (_/_) | (_/_) |
| [2902] | Template 3 | (_/_) | (_/_) |
| [2903] | Template 4 | (_/_) | (_/_) |
| [2904] | Template 5 | (_/_) | (_/_) |
| [2905] | Template 6 | (_/_) | (_/_) |

| | | | |
|--------|-------------|---------|---------|
| [2906] | Template 7 | (/ /) | (/ /) |
| [2907] | Template 8 | (/ /) | (/ /) |
| [2908] | Template 9 | (/ /) | (/ /) |
| [2909] | Template 10 | (/ /) | (/ /) |
| [2910] | Template 11 | (/ /) | (/ /) |
| [2911] | Template 12 | (/ /) | (/ /) |
| [2912] | Template 13 | (/ /) | (/ /) |
| [2913] | Template 14 | (/ /) | (/ /) |
| [2914] | Template 15 | (/ /) | (/ /) |

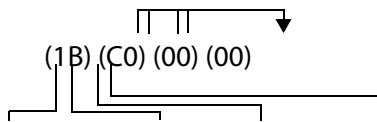

| | Button 1 | Button 2 | Button 3 | Button 2+3 | Disarm |
|------------------------|-------------|---------------|---------------|------------|-------------------------------|
| MG-REM1 | | | | | |
| MG-REM2 | | | | | |
| Default (1 B) (C 0) | Regular Arm | Utility Key 1 | Utility Key 2 | Disabled | Disarm: cannot be modified |

Table 3: Template Entries

| Entry | Function | Entry | Function |
|-------|-----------------|---------------------|---------------|
| [0] | Button Disabled | [8] | Panic 1 |
| [1] | Regular Arm | [9] | Panic 2 |
| [2] | Stay Arm | A = [stay] | Panic 3 |
| [3] | Instant Arm | B = [force] | Utility Key 1 |
| [4] | Force Arm | C = [arm] | Utility Key 2 |
| [5] | N/A | D = [disarm] | Utility Key 3 |
| [6] | N/A | E = [byp] | Utility Key 4 |
| [7] | N/A | F = [mem] | N/A |

6.1 Keyswitch Numbering

SECTIONS [0501] TO [0532]

Keyswitch Numbering allows you to assign any hardwired input in the system to any of the 32 keyswitch zones in the control panel (see *Figure 15*). **UL Note:** Do not use Keyswitches in UL Listed systems.

Figure 15: Example of Keyswitch Numbering

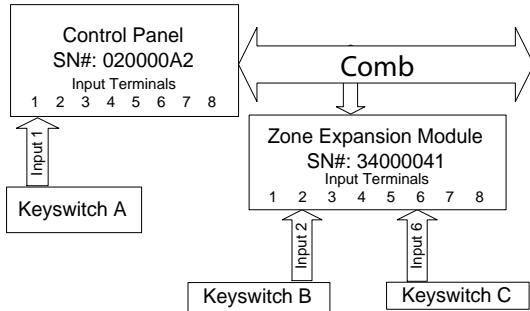

| Keyswitch | Zone # | Section | Serial# | Input# |
|--------------|--------|---------|----------|--------|
| Keyswitch A: | 1 = | [0501] | 020000A2 | 001 |
| Keyswitch B: | 2 = | [0502] | 34000041 | 002 |
| Keyswitch C: | 3 = | [0503] | 34000041 | 006 |

6.2 Keyswitch Definitions

Keyswitch Definitions determine how a keyswitch is used.

6.2.1 Keyswitch Disabled

SECTIONS [0601] TO [0632]: FIRST DIGIT = 0

Disables keyswitch input.

6.2.2 Momentary Keyswitch

SECTIONS [0601] TO [0632]: FIRST DIGIT = 1

To arm or disarm a partition using the Momentary Keyswitch, turn on the keyswitch for three seconds then turn it off.

6.2.3 Maintained Keyswitch

SECTIONS [0601] TO [0632]: FIRST DIGIT = 2

To arm a partition using the Maintained Keyswitch, turn the switch from the ON to the OFF position. Disarm it by setting the key on the ON position.

6.2.4 Generates a Utility Key Event on Open

SECTIONS [0601] TO [0632]: FIRST DIGIT = 3

To program a keyswitch to generate a Utility Key Event:

1. Program the Activation Event of a PGM output with the *Utility Key Event* corresponding to the desired keyswitch (see *PGM Programming Table* in the "EVO Programming Guide": Event Group 048).
2. Enable option [3] in the section corresponding to the desired keyswitch.

6.2.5 Generates a Utility Key Event on Open and Close

SECTIONS [0601] TO [0632]: FIRST DIGIT = 4

A Utility Key Event can be generated whenever the keyswitch input is opened or closed. The Utility Key Events increase from 32 to 64 events; one event for each state.

When a keyswitch is defined with the Generate a Utility Key Event on Open and Close option, the Keyswitch Partition Assignment and Keyswitch Options are disabled. To program a keyswitch to generate a Utility Key Event:

1. Program the Activation Event of a PGM output with the *Utility Key Event* corresponding to the desired keyswitch (see *PGM Programming Table* in the "EVO Programming Guide": Event Group 048).
2. Enable option **[4]** in the section corresponding to the desired keyswitch.

6.3 Keyswitch Partition Assignment

SECTIONS [0601] TO [0632]: SECOND DIGIT = 1 TO 8

Each keyswitch must be assigned to one partition.

6.4 Keyswitch Options

Each keyswitch zone can be programmed with one or more options.

6.4.1 Disarm Only

Sections [0601] to [0632]: Option [3]

When enabled, the keyswitch can only disarm assigned partitions. The type of disarming is determined by the other Keyswitch Options selected.

6.4.2 Stay/Instant Disarm Option (Keyswitch)

SECTIONS [0601] TO [0632]: OPTION [4]

When enabled, the keyswitch can only disarm assigned Stay or Instant armed partitions. When option **[4]** is disabled, the keyswitch can disarm partitions armed using any arming method.

6.4.3 Arm Only (Keyswitch)

SECTIONS [0601] TO [0632]: OPTION [5]

When enabled, the keyswitch can only arm assigned partitions. The type of arming is determined by the other Keyswitch Options selected.

6.4.4 Regular Arming (Keyswitch)

SECTIONS [0601] TO [0632]: OPTION [6] TO [8]

With disabled, the arming option will be Regular arming.

6.4.5 Stay Arming (Keyswitch)

SECTIONS [0601] TO [0632]: OPTION [6]

Activating the keyswitch will Stay Arm the partition.

6.4.6 Force Arming (Keyswitch)

SECTIONS [0601] TO [0632]: OPTION [7]

Activating the keyswitch will force arm the selected partition.

6.4.7 Instant Arming (Keyswitch)

SECTIONS [0601] TO [0632]: OPTION [8]

This option is identical to Stay arming except that all armed zones will become Instant Zones.



Only one of the arming options (Stay, Force, Instant and Regular) can be selected.

7.0.1 EVO192 Panel

The Digiplex EVO is a security and access control system with 8 on-board zone inputs (16 with zone doubling) that is expandable to 48 or 192 zones via the 4-wire combus. The EVO control panel features up to 999 users, 8 partitions, 32 doors and can support up to 254 modules in any combination.

The Digiplex EVO system provides the highest level of protection for banks, high-security military and government sites, luxurious residential homes and any place where maximum security is essential. These systems are designed to be easy to use, and the modular concept of these systems provides installers with labour-saving features that make expanding, installing and servicing these systems quick and convenient.

Expand the EVO system by adding plug-and-play expansion modules anywhere and in any combination on the 4-wire combus. Modules are connected to the combus at the most convenient location and then their zone inputs are assigned to the desired zone and partition. Also, only a module's used inputs are assigned to zones in the system. Keyswitches, remote controls and unused module inputs do not use up zones. Once installed, all combus modules, including motion detectors, can be programmed remotely via a keypad or the WinLoad upload/download software.

EVO also supports 32 virtual zones in addition to its security zones and access control doors. Virtual zones can be used to automate PGM activations without occupying a security zone and without affecting the system's security functions. The EVO system is a logical solution to every installer's security, access control and home automation installation needs.

Features of EVO192 Controller

- Digital combus:
- Provides constant power, supervision and two-way communication between the control panel and all its modules
- Supports up to 127 modules
- Connect modules up to 914m (3000ft) from the panel²
- Sabotage-proof technology without additional wiring
- 8 on-board zones (16 w/ zone doubling) expandable to 192 zones via 4-wire combus
- Automatic Daylight Saving Time feature
- 2 on-board solid-state relays PGM outputs (+ 3 optional), negative or positive triggering
- PGM1 can be used as a 2-wire smoke input³
- Built-in-real-time clock backup battery
- 1 supervised bell output, auxiliary output and telephone line
- Push button software reset (reset to default values and restart)
- Push button to activate or deactivate the Auxiliary output

Note: Connection of non ETL/UL listed component will void the ETL listing

Note: Connect according to the wiring requirements described in the Wiring Diagram

Note: 2-Wire Smoke Detector was not evaluated by ETL

- Fits in a 28cm x 28cm x 7.6cm (11in x 11in x 3in) metal box
- 5 on-board solid-state PGM outputs, negative or positive triggering

- Supports up to 254 expansion bus modules
- 999 user codes
- 8 partitions
- 2048 events buffered

Specifications

Control Panel

AC Power: 17Vac, 40VA, 60Hz

Battery: 12Vdc, 7Ah

Auxiliary Power: 11.4 to 12.5Vdc, 700mA maximum, fuseless shutdown at 1.1A

Bell Output: 11.4 to 12.5Vdc, 1A maximum, fuseless shutdown @ 3A

PGM Output: PGM1 to PGM4 100mA solid-state relays with +/- trigger, PGM5 Form C relay output rated at 5A/28Vdc N.O. / N.C.

Max current/Power 40VA

Operational Temperature: -20°C to +50°C (4°F to +122°F)

All control panel outputs are rated to operate between 11.4Vdc and 12.5Vdc

Electrical ratings (current, power) on the product or in the installation instructions. Missing Current / Power

Specifications may change without prior notice.

General Note 1

Please note that only LCD and Grafica keypads can be used to program the EVO system. LED keypads cannot be used to program the system.

General Note 2

Please note that the steps may differ when programming with the Grafica keypad (DNE-K07). If not indicated, refer to the complete "Grafica User Manual", which can be downloaded for free from our website at paradox.com

See Component Installation guides at the end of this document for Installation instructions.

7.0.2 Hub Module HUB2

The APR3-HUB2 is a non-addressable module that extends and divides the control panel's bus into two completely isolated bus outputs (two for each connected APR3-HUB2). It extends the combus/communication bus by regenerating the signal between the control panel and its modules. Should one bus output experience trouble or tampering, the other will remain unaffected. The hub monitors the signal between the control panel and modules on each output. If the hub detects a loss of signal integrity it will cut off the troubled output until proper communication is reestablished.

See Component Specifications and Installation guides at the end of this document for Installation instructions.

7.0.3 Hardwired keypad K641

The K641 Keypad allows you to control your Paradox system's functions through its keypad interface.

Specifications

| | |
|-------------------|---|
| Operating Voltage | 9 to 16Vdc |
| Operating Temp. | -10 to 55°C (14 to 131°F) |
| Power Consumption | Maximum current - 150mA |
| Dimensions | 15 x 12.6 x 2.7 cm (6 x 4.9 x 1.06 in.) |
| Weight | 230g (8.1 oz) |
| Humidity | 5-93% |
| Compatibility | EVO192 v2.16 or higher and EVOHD V1.0 or higher |
| Compliance | EN50131-3 Grade 3; Environmental Class II |

See Component Specifications and Installation guides at the end of this document for Installation instructions.

7.0.4 Hardwired keypad TM50

The TM50 Touch Intuitive Touchscreen allows you to control your Paradox system's functions through its touchscreen interface.

See Component Specifications and Installation guides at the end of this document for Installation instructions.

7.0.5 IP communication module IP150

The IP150 Internet Module is an HTTPs-supported IP communication device that enables you to control and monitor your security system through any web browser (e.g., Google Chrome). The IP150 provides freedom to access your system and receive instant, SSL encrypted email notifications anywhere in the world when your system detects activity. So no matter where you are, you will have access to arm, disarm, and more.

See Component Specifications and Installation guides at the end of this document for Installation instructions.

7.0.6 Wireless Expansion Module RTX3

The RTX3 is a 2-way, 32 zone wireless expansion module which enables Imperial, DGP/EVO, Spectra SP Series or Esprit control panels to support wireless hardware such as motion detectors and remote controls.

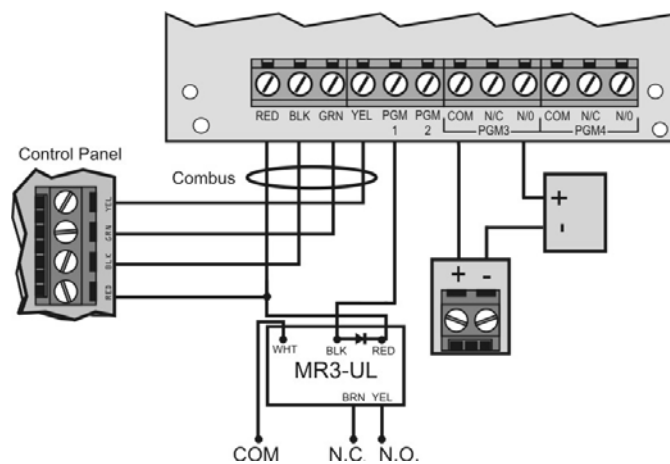

Figure 16 – RTX3 Wiring

See Component Specifications and Installation guides at the end of this document for Installation instructions.

7.1 ZX8 Expansion Module

The 8-zone Expansion Module (ZX8) is an interface between the control panels and any hardwired detection devices. The ZX8 connects to the control panel's combus to provide eight additional hardwired inputs and one 50mA on-board PGM output.

See Component Specifications and Installation guides at the end of this document for Installation instructions.

7.2 Programming Locations

This panel can be programmed at all K641 Keypads or TM50 touchpads connected to the system.

7.3 Testing and Maintenance

Note: This system must be checked by a qualified technician at least once every three (3) years.

Note: The security system should be tested weekly by the master user or his assignee.

Note: The tester should always notify the CMS before starting a test.

Note: This system must be checked monthly with the primary ac power de-energized.

Note: Automatic Termination of System Test Mode is not supported.

Maintenance of smoke detectors must be done. To keep your equipment in excellent working order, ongoing monthly maintenance is required as outlined above and as per UL and NFPA standards. A preventative maintenance agreement should be arranged through the local manufacturer's representative. Though smoke detectors are designed for long life, they may fail at any time. Any smoke detector, fire alarm equipment, or any component of that system which fails must be repaired or replaced as soon as possible.

7.3.1 Burglar Alarm Testing

Two people are needed to complete this test. One person will watch the screen on the keypad while the other person walks around the protected areas and opens the zones.

(i.e. opens the doors and windows that are protected, walk in the path of the motion detectors, etc.). The screen will display the opened zones, but if a zone does not register, contact your installer.

7.3.2 Fire Alarm Testing

Do NOT use an open flame or burning materials to test your fire detection devices. Your installer will provide details on the best way to test your system.

Note: The smoke detector model SD360 shall be tested and maintained according to its installation guide ref. SD360-EI00.

7.3.3 System Maintenance

Under normal use your system requires no maintenance other than regular testing. We recommend that your installer change the battery every three years.

Lamp and fuse replacement –

Battery maintenance and replacement –

Name and address of service people to contact in event of trouble –

Loss of AC power –

Low battery –

7.3.4 System Test

Speak to your installer before conducting a System Test since the system must be programmed to respond to the test instructions. It is normally recommended that you conduct the system test once a week, but contact your installer for instructions concerning your particular system.

To conduct the system test see see *Installer Function Keys* on page 90

The system will test all its connections and can send a report to your monitoring station.

If the system detects a problem, the Trouble Display will show on the screen (refer to section 9.0 on page 19). Call your installer for repairs if any troubles occur.

7.3.5 Beep on Trouble

This system can be configured to beep with the following trouble indications:

- System and clock trouble beep
- Communicator trouble beep
- Module and combus trouble beep
- All zone trouble beep

See the EVO programming guide for instructions on enabling audible trouble notices through the keypad or through Babyware.

7.3.6 Replacement Parts

The following parts are replaceable.

1. Main backup battery 12Vdc 7Ah rechargeable acid/lead backup battery
2. AC/AC transformer
For US: UL/ETL Listed Class 2 wall/building 120VAC/60Hz power supply with restraining means.
For Canada: CSA/ULc/ETLc Listed Class 2 Power Supply with NO restraining mean
Must be Listed to the LSS standard or must be Surge protected Power supply
For residential installations use transformer made by Universal Power Group model: UB1640W
3. Use UL Approved fuses FAST BLOW 5A/125V 5X20MM

7.3.7 End User Instructions

Need to fill in

Normal standby –

Alarm –

Alarm test –

Alarm silence –

Trouble –

Trouble silence –

Off-normal position of switches –

Functions of lights, switches –

1. To prevent risk of shock, disconnect telephone line at telco jack before servicing this unit.

Note: For ETL and UL The minimum permissible wire size to be employed shall be not smaller than No. 22 AWG (0.32 mm²).

2. Use rubber bushings to protect the wires going through the metal housing.
3. Ground the metal box to a valid ground post or according to local electrical codes.
4. **Do not use any switch-controlled outlets to power the transformer.** The system should be connected to the building's power source (grounded outlet) with an AC/AC transformer.
5. Use a UL approved transformer. Use only LSS standard or a surge protected power supply.
For residential installations use transformer made by Universal Power Group model: UB1640W
6. The maximum charging current for the battery is 1 amp. For UL installation 850ma charging current is required.
7. Use only Metal boxes to comply with ANSI/NFPA 72.
8. To prevent risk of electric shock, disconnect AC, battery, and phone cord BEFORE Servicing.
9. The knockouts in this box are compatible with standard conduit.
10. Main Supply Circuit – 110V, 60 Hz, with a transformer of max. power 40VA must be Listed to the LSS standard or must be Surge protected Power supply.
For residential installations use transformer made by Universal Power Group model: UB1640W
11. The system should be installed in accordance with Chapter 2 of the National Fire Alarm Code, ANSI/NFPA 72
12. Installation of Residential Fire Warning Systems shall be in accordance with CAN/ULC-S540;
13. The panel will cease to process sensor trips if the voltage is under 8.5V.
14. Do no short the terminals of the transformer together. This causes the internal fuse to blow.
15. For the US and Canada: The transformer must be connected to a 110VAC/60Hz, 24-hour outlet which is not controlled by a switch other than an approved over-current protection device. Must be Listed to the LSS standard or must be Surge protected Power supply.
For residential installations use transformer made by Universal Power Group model: UB1640W
16. For continued protection against risk of fire, replace fuses only with fuses of the same type and rating.
17. Install part TK278 Tamper kit in the panel metal box.
18. Wiring methods shall be in accordance with the National Electrical Code, ANSI/NFPA 70, the Standard for Installation and Classification of Burglar and Holdup Alarm Systems, UL 681, and the Standard for Central-Station Alarm Services, UL 827.
19. Wiring methods in keeping with the requirements of CSA C22.1, Canadian Electrical Code, Part I, Safety Standard for Electrical Installations.
20. Connect a power on LED that shows when there is board power visible from outside of the box. The wires need to be connected to one of the AC terminals and the other to the COM terminal.

Note: Using any non-UL approved components will invalidate the UL certification of this system.

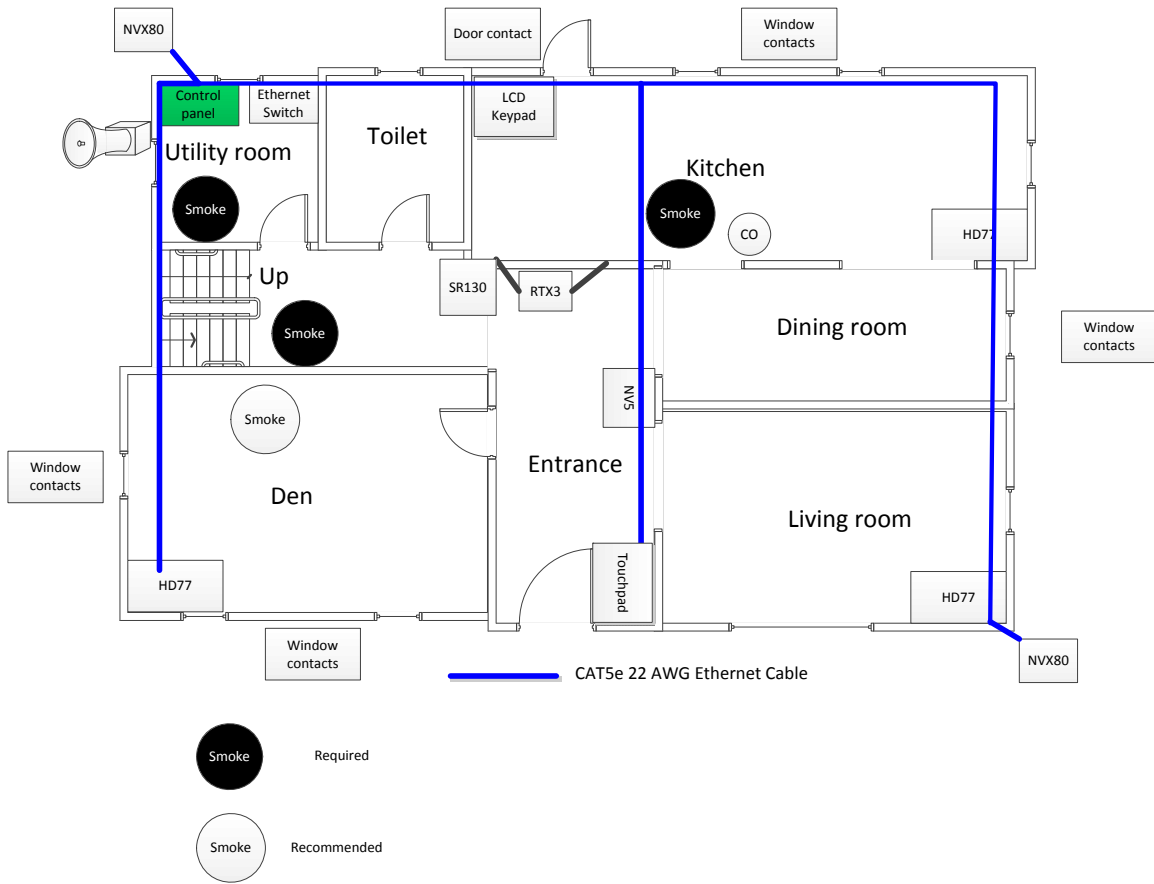

Figure 17 – Typical System Layout Ground Floor Installation



Figure 18 – Typical 2nd Floor Installation

The EVO192 is equipped with protective features such as fuses, MOVs, PTC etc. Removal, damage to or bypassing any of these features may result in injury and/or damage to the EVO192 system.

Bypassing the tamper and anti mask features will result in reduced effectiveness of your security system.

Note: The phone line between the protected property and the communications service provider shall be for the exclusive use of the protected property and is not to be shared with other communications service provider subscribers.

Note: Do NOT program this system or any of its modules to automatically place a call to a police station number that has not been specifically assigned by that police station for such a service.

7.4 Call Waiting Cancel

1. Section 4.5 requires a programmable option for call waiting cancel shall be required on communicators that use media (e.g. PSTN) where call-waiting may be provisioned.

The programming for this feature must be added to the Programming Guide.

The installer needs to verify the code in the premises area for the telephone network that disables the call waiting feature, then add it to the monitoring station number.

For example:

Receiving center phone number: 999-999-999

Call waiting cancellation code: *70

Phone number to program: *70P999999999

) Instructions that an automatic telephone dialer or similar device shall not be set or programmed to place a call to a police station number that has not been specifically assigned by that police station for such service. The instructions may be incorporated on the inside of the product, on a separate sheet, or as part of a manual. If not included directly on the product, the instructions or manual shall be referenced in the marking information on the product. .

Note: Do NOT program this system or any of its modules to automatically place a call to a police station number that has not been specifically assigned by that police station for such a service.

7.5 Testing and Maintenance

7.5.1 Burglar Alarm Testing

Two people are needed to complete this test. One person will watch the screen on the keypad while the other person walks around the protected areas and opens the zones.

(i.e. opens the doors and windows that are protected, walk in the path of the motion detectors, etc.). The screen will display the opened zones, but if a zone does not register, contact your installer.

7.5.2 Fire Alarm Testing

Do NOT use an open flame or burning materials to test your fire detection devices. Your installer will provide details on the best way to test your system.

7.5.3 System Maintenance

Under normal use your system requires no maintenance other than regular testing. We recommend that your installer change the battery every three years.

7.5.4 System Test

Speak to your installer before conducting a System Test since the system must be programmed to respond to the test instructions. It is normally recommended that you conduct the system test once a week, but contact your installer for instructions concerning your particular system.

The system will test all its connections and can send a report to your monitoring station.

If the system detects a problem, the Trouble Display will show on the screen (refer to section 9.0 on page 19). Call your installer for repairs if any troubles occur.

7.5.5 Replacement Parts

The following parts are replaceable.

1. Main backup battery must be a 12Vdc 7Ah rechargeable acid/lead battery.

2. AC/ AC transformer
The transformer must be to the LSS standard or be connected to a surge protected power supply.
For residential installations use transformer made by Universal Power Group model: UB1640W
3. For US: UL/ETL Listed Class 2 wall/building 120VAC/60Hz power supply with restraining means.
For Canada: CSA/ULc/ETLc Listed Class 2 Power Supply with NO restraining means
4. Fuse UL Approved FUSE FAST BLOW 5A/125V 5X20MM

8.1 Arming Follows Partition

(default = **disabled**) A partition can be set to follow the arming and disarming status of one or more partitions.

| | |
|----------------------------|--------------------------------|
| Section: | Partition arms & disarms with: |
| Partition 1: [3121] | Option [1] = Partition 1 |
| Partition 2: [3221] | Option [2] = Partition 2 |
| Partition 3: [3321] | Option [3] = Partition 3 |
| Partition 4: [3421] | Option [4] = Partition 4 |
| Partition 5: [3521] | Option [5] = Partition 5 |
| Partition 6: [3621] | Option [6] = Partition 6 |
| Partition 7: [3721] | Option [7] = Partition 7 |
| Partition 8: [3821] | Option [8] = Partition 8 |

8.2 Trouble Latch

SECTION [3033]: OPTION [6]

With the Trouble Latch feature disabled, when a trouble occurs and is corrected, the trouble is automatically cleared and no longer displayed. With the Trouble Latch feature enabled, the trouble will remain displayed until it is manually cleared by the user. To clear the trouble, the user must enter the trouble display and then exit the trouble display. For LCD and LED keypads, press **[CLEAR]** to exit. For Grafica keypads, press the left action key (**Back**) to exit.



Only troubles that have been corrected can be cleared. If a trouble has not been corrected, it will continue to be displayed even if the user tries to clear the trouble by using the method described above.

8.3 Restrict Arming on Supervision Loss

SECTION [3034]: OPTION [4]

(default = **disabled**) When enabled, arming is restricted if a supervision loss signal from the Magellan Wireless System MG-RTX3 is received.

8.4 Restrict Arming on Tamper

SECTION [3034]: OPTION [8]

(default = **disabled**) When enabled, the control panel prevents arming if it detects a tamper on a zone or module (see *section 9.5* on page 62). Partitions will not arm until the Installer Code is entered and the tamper trouble conditions are corrected.

8.5 Restrict Arming on AC Failure

SECTION [3035]: OPTION [1]

(default = **disabled**) When enabled, the control panel prevent arming if it detects a loss of AC power.

8.6 Restrict Arming on Battery Failure

SECTION [3035]: OPTION [2]

(default = **disabled**) When enabled, the control panel prevents arming if it detects a battery loss or if the battery voltage is less than 10.5V.

8.7 Restrict Arming on Bell or Auxiliary Failure

SECTION [3035]: OPTION [3]

(default = **disabled**) When enabled, the control panel prevents arming if:

- the bell or siren is disconnected
- the Bell Output has exceeded its current limits
- the Auxiliary Outputs have exceeded their current limits

8.8 Restrict Arming on TLM Failure

SECTION [3035]: OPTION [4]

(default = **disabled**) When enabled, the control panel can prevent arming if it is unable to access the telephone line.

8.9 Restrict Arming on Module Troubles

SECTION [3035]: OPTION [5]

(default = **disabled**) When is enabled, the control panel uses the same Restrict Arming options for the modules connected to the combus.

8.10 Timed Auto-Arming

(default = **disabled**) The control panel arms the selected partition every day at the time set (see *section 8.10.1*). A 60-second Exit Delay (default value) triggers before the partition arms. It can be cancelled or postponed by entering a valid access code. If zones are open, the control panel arms the partition and considers all open zones as temporarily bypassed (except 24hr. zones). The control panel transmits the *Auto-Arming* report code programmed in section [3910]. The control panel will transmit the *Late to Close* report code programmed in section [3912]. Enable option [1] in the desired section:

| | | | |
|---------------------|---------------------|---------------------|---------------------|
| Partition 1: [3122] | Partition 3: [3322] | Partition 5: [3522] | Partition 7: [3722] |
| Partition 2: [3222] | Partition 4: [3422] | Partition 6: [3622] | Partition 8: [3822] |

8.10.1 Auto-Arm Timer

Enter the time when the partition should arm in the desired section:

| | | | |
|---------------------|---------------------|---------------------|---------------------|
| Partition 1: [3101] | Partition 3: [3301] | Partition 5: [3501] | Partition 7: [3701] |
| Partition 2: [3201] | Partition 4: [3401] | Partition 6: [3601] | Partition 8: [3801] |

8.10.2 Postpone Auto-Arming

(default = **000**) It is possible to postpone auto-arming for a preset amount of time by entering a valid user code during the exit delay. The delay is set by entering a number between 001 and 255 in the appropriate section. That number represents for how many increments of 15 minutes the arming will be postponed.

| | | | |
|---------------------|---------------------|---------------------|---------------------|
| Partition 1: [3120] | Partition 3: [3320] | Partition 5: [3520] | Partition 7: [3720] |
| Partition 2: [3220] | Partition 4: [3420] | Partition 6: [3620] | Partition 8: [3820] |

8.11 No Movement Auto-Arming

(default = **disabled**) If no movement occurs in a partition for the specified period, the control panel will automatically arm that partition. The Auto-Arming Option determines the arming method (see *section 8.12*). The control panel will transmit the *No Movement* report code programmed in section [3913] upon arming. The control panel will always transmit the *Late to Close* report code [3912]. Enable option [2] in the desired section:

| | | | |
|---------------------|---------------------|---------------------|---------------------|
| Partition 1: [3122] | Partition 3: [3322] | Partition 5: [3522] | Partition 7: [3722] |
|---------------------|---------------------|---------------------|---------------------|

| | | | |
|---------------------|---------------------|---------------------|---------------------|
| Partition 2: [3222] | Partition 4: [3422] | Partition 6: [3622] | Partition 8: [3822] |
|---------------------|---------------------|---------------------|---------------------|

8.11.1 No Movement Timer

(default = **000**) Select the section corresponding to the desired partition and program the time without movement necessary before the control panel will arm and/or send the *No Movement* report code. If No Movement Auto-Arming is disabled, the control panel can still send the *No Movement* report code. Enter the time period (001 to 255 x 5 minutes, 000 = disabled) when the partition should arm in the desired section:

| | | | |
|---------------------|---------------------|---------------------|---------------------|
| Partition 1: [3107] | Partition 3: [3307] | Partition 5: [3507] | Partition 7: [3707] |
| Partition 2: [3207] | Partition 4: [3407] | Partition 6: [3607] | Partition 8: [3807] |

8.11.2 No Movement Schedule

It is possible to program the No-movement arming option for each partition to follow a schedule. These schedules, which function like access schedules, will ensure that No-Movement arming only occurs during these specified periods and not at any moment when there is no movement. When option [8] is enabled, access is permitted during the programmed holidays.

No Movement Schedule

| | | | |
|---------------------|---------------------|---------------------|---------------------|
| Partition 1: [3131] | Partition 3: [3331] | Partition 5: [3531] | Partition 7: [3731] |
| Partition 2: [3231] | Partition 4: [3431] | Partition 6: [3631] | Partition 8: [3831] |

| Option | Day | Option | Day |
|--------|---------------|--------|--------------|
| [1] | Sunday (S) | [5] | Thursday (T) |
| [2] | Monday (M) | [6] | Friday (F) |
| [3] | Tuesday (T) | [7] | Saturday (S) |
| [4] | Wednesday (W) | [8] | Holidays (H) |

8.12 Auto-Arming Options

(default = **disabled**) When using the Auto-Arming features (see *section 8.10* and *section 8.11*), the control panel can Force arm or Stay arm the partitions. To Auto-Arm using Stay arming, enable option [3] in the desired section:

| | | | |
|---------------------|---------------------|---------------------|---------------------|
| Partition 1: [3122] | Partition 3: [3322] | Partition 5: [3522] | Partition 7: [3722] |
| Partition 2: [3222] | Partition 4: [3422] | Partition 6: [3622] | Partition 8: [3822] |

8.13 Switch To Stay Arming

If no Entry Delay zones are opened and closed during the Exit Delay after Regular arming a partition, the control panel can switch from Regular arming to Stay arming. Enable the option in the desired section:

| | |
|--------------------------------|--------------------------------|
| Partition 1: [3121] Option [1] | Partition 5: [3521] Option [5] |
| Partition 2: [3221] Option [2] | Partition 6: [3621] Option [6] |
| Partition 3: [3321] Option [3] | Partition 7: [3721] Option [7] |
| Partition 4: [3421] Option [4] | Partition 8: [3821] Option [8] |

8.14 Always Force Arm when Regular Arming

(default = **disabled**) When enabled for a particular partition, the system will Force arm that partition whenever Regular or Force arming is activated. Stay and Instant arming are not affected by this feature. An event will be

generated for every zone bypassed in that manner. Another event will be generated when the zone will be closed. Enable option **[8]** in the desired section:

| | | | |
|----------------------------|----------------------------|----------------------------|----------------------------|
| Partition 1: [3123] | Partition 3: [3323] | Partition 5: [3523] | Partition 7: [3723] |
| Partition 2: [3223] | Partition 4: [3423] | Partition 6: [3623] | Partition 8: [3823] |

8.15 Auto Force on Stay Arming

(default = **disabled**) When enabled for a particular partition, the system will Force arm that partition whenever Stay arming is activated. An event will be generated for every zone bypassed in that manner. Another event will be generated when the zone will be closed. Enable option **[4]** in the desired section

| | | | |
|----------------------------|----------------------------|----------------------------|----------------------------|
| Partition 1: [3126] | Partition 3: [3326] | Partition 5: [3526] | Partition 7: [3726] |
| Partition 2: [3226] | Partition 4: [3426] | Partition 6: [3626] | Partition 8: [3826] |

8.16 Follow Zone Switches to Entry Delay 2

(default = **enabled**) When enabled and an Entry Delay zone is bypassed, an armed Follow Zone that opens without an Entry Delay being triggered will switch to the partition's Entry Delay 2. Enable option **[8]** in the desired section:

| | | | |
|----------------------------|----------------------------|----------------------------|----------------------------|
| Partition 1: [3122] | Partition 3: [3322] | Partition 5: [3522] | Partition 7: [3722] |
| Partition 2: [3222] | Partition 4: [3422] | Partition 6: [3622] | Partition 8: [3822] |

8.17 One-Touch Features

(default = **disabled**) The One-Touch features can arm or disarm a partition, access Bypass Programming, or display the Event Buffer by pressing and holding a specific key for 2 seconds instead of entering an access code. If the keypad is assigned to more than one partition, the feature must be enabled in the corresponding partitions. Select the section corresponding to the desired partition and enable or disable the desired options:

| | | | |
|----------------------------|----------------------------|----------------------------|----------------------------|
| Partition 1: [3125] | Partition 3: [3325] | Partition 5: [3525] | Partition 7: [3725] |
| Partition 2: [3225] | Partition 4: [3425] | Partition 6: [3625] | Partition 8: [3825] |

| Option | One-Touch Feature | One-Touch Key |
|------------|------------------------|-----------------|
| [1] | Regular Arming | [ARM] |
| [2] | Stay Arming | [STAY] |
| [3] | Instant Arming | [5] |
| [4] | Force Arming | [FORCE] |
| [5] | Stay/Instant Disarming | [DISARM] |
| [6] | Bypass Programming | [BYP] |
| [7] | Event Record Display | [7] |

8.18 Exit Delay

(default = **060**) The Exit Delay is the amount of time users have to leave the protected area before arming. It applies to all zones, except 24Hr Zones. Program the Exit Delay from 001 to 255 seconds:

| | | | |
|----------------------------|----------------------------|----------------------------|----------------------------|
| Partition 1: [3108] | Partition 3: [3308] | Partition 5: [3508] | Partition 7: [3708] |
| Partition 2: [3208] | Partition 4: [3408] | Partition 6: [3608] | Partition 8: [3808] |

8.18.1 Exit Delay Termination

(default = **enabled**) The control panel can reduce the Exit Delay to 7 seconds when an Entry Delay zone is opened and closed during the delay.

Enable option **[4]** in the desired section:

| | | | |
|----------------------------|----------------------------|----------------------------|----------------------------|
| Partition 1: [3122] | Partition 3: [3322] | Partition 5: [3522] | Partition 7: [3722] |
| Partition 2: [3222] | Partition 4: [3422] | Partition 6: [3622] | Partition 8: [3822] |

8.18.2 No Exit Delay on Remote Arm

(default = **enabled**) When a user arms by using a remote control from the Magellan Wireless System (MG-RTX3), the control panel will cancel the Exit Delay and immediately arm the partition. Enable option **[8]** in the desired section:

| | | | |
|----------------------------|----------------------------|----------------------------|----------------------------|
| Partition 1: [3125] | Partition 3: [3325] | Partition 5: [3525] | Partition 7: [3725] |
| Partition 2: [3225] | Partition 4: [3425] | Partition 6: [3625] | Partition 8: [3825] |

8.18.3 Special Arming Exit Delay

(default = **060**) This allows to set an exit delay in seconds for a special arming. Special arming are any arming that do happen without interacting with a keypad (i.e.: scheduled arming, keyswitch arming, WinLoad arming, no movement arming, etc.)

| | | | |
|----------------------------|----------------------------|----------------------------|----------------------------|
| Partition 1: [3130] | Partition 3: [3330] | Partition 5: [3530] | Partition 7: [3730] |
| Partition 2: [3230] | Partition 4: [3430] | Partition 6: [3630] | Partition 8: [3830] |

8.19 Keypad Lock-out Feature

(default = **005**) If a consecutive number of invalid codes are entered into a keypad, the control panel can be set to lockout access from all the keypads in the partition for a specified period. Program the number of consecutive invalid codes from 001 to 255 (000 = disabled) into the desired section:

| | | | |
|----------------------------|----------------------------|----------------------------|----------------------------|
| Partition 1: [3105] | Partition 3: [3305] | Partition 5: [3505] | Partition 7: [3705] |
| Partition 2: [3205] | Partition 4: [3405] | Partition 6: [3605] | Partition 8: [3805] |

(default = **015**) Program the duration of the keypad lockout from 001 to 255 minutes into the desired section. Programming 000 into these sections will not lockout the keypad, the control panel will transmit the Keypad Lockout report code programmed in section **[3937]**.

| | | | |
|----------------------------|----------------------------|----------------------------|----------------------------|
| Partition 1: [3106] | Partition 3: [3306] | Partition 5: [3506] | Partition 7: [3706] |
| Partition 2: [3206] | Partition 4: [3406] | Partition 6: [3606] | Partition 8: [3806] |

8.20 Bell Squawk

The control panel can activate the bell output briefly causing the bell or siren to squawk to alert users that a partition is being armed, disarmed or that an Entry or Exit Delay was triggered. Enable or disable the desired option (off = disabled):

| | | | |
|----------------------------|----------------------------|----------------------------|----------------------------|
| Partition 1: [3124] | Partition 3: [3324] | Partition 5: [3524] | Partition 7: [3724] |
| Partition 2: [3224] | Partition 4: [3424] | Partition 6: [3624] | Partition 8: [3824] |

| Option | Bell Squawk on: | Description |
|------------|-----------------|---|
| [1] | Disarming | Emits 2 squawks upon disarming (default = disabled) |
| [2] | Arming | Emits 1 squawk upon arming (default = disabled) |

| | | |
|-----|-------------------------|--|
| [3] | Auto-Arming | Emits 1 squawk every second for 60s before Auto-Arming a partition. Emits a series of 3 squawks every second for 10s before arming (default = disabled) |
| [4] | Exit Delay | Emits 1 squawk every second during the Exit Delay. Emits a series of 3 squawks every second during the final 10 seconds of the Exit Delay (default = disabled) |
| [5] | Entry Delay | Emits 1 squawk every second during the Entry Delay (default = disabled) |
| [6] | Remote Arming/Disarming | Emits 1 squawk upon arming and 2 squawks upon disarming with a remote control (using the Magellan Wireless System, MG-RTX3 (default = enabled)) |

8.21 Ring-back

After disarming the system, the control panel can warn the user that there was an alarm and that it may be dangerous to enter by having the keypad beep 10 times and/or by squawking the bell 10 times. The user should leave immediately and contact the monitoring station from a secure location. Select the section that corresponds to the desired partition and enable or disable the desired option (off = disabled) (default = **disabled**):

| | | | |
|---------------------|---------------------|--------------------------------|---------------------|
| Partition 1: [3124] | Partition 3: [3324] | Partition 5: [3524] | Partition 7: [3724] |
| Partition 2: [3224] | Partition 4: [3424] | Partition 6: [3624] | Partition 8: [3824] |
| [7] | Bell Ring-back | Bell or siren emits 10 squawks | |
| [8] | Keypad Ring-back | Keypad emits 10 beeps | |

8.22 Maximum Bypass Entries

(default = **000**) The Maximum Bypass Entries feature limits the number of zones that can be bypassed in each partition. Enter any value between 001 and 096 (000 = no limit).

| | | | |
|---------------------|---------------------|---------------------|---------------------|
| Partition 1: [3115] | Partition 3: [3315] | Partition 5: [3515] | Partition 7: [3715] |
| Partition 2: [3215] | Partition 4: [3415] | Partition 6: [3615] | Partition 8: [3815] |

8.23 Display "Bypass" If Armed

SECTION [3033]: OPTION [5]

(default = **enabled**) When enabled, the keypads will not display that zones have been bypassed while the system is armed.

9.1 Bell/alarm Output

(default = **only option [1] enabled**) When an alarm condition is detected in a partition, the control panel can trigger the on-board BELL output enabling any bells or sirens connected to it. In section [3032] enable the option to enable the bell output in the desired partition (off = disabled):

| | |
|-------------------------|-------------------------|
| Partition 1: Option [1] | Partition 5: Option [5] |
| Partition 2: Option [2] | Partition 6: Option [6] |
| Partition 3: Option [3] | Partition 7: Option [7] |
| Partition 4: Option [4] | Partition 8: Option [8] |

9.2 Bell Cut-off Timer

(default = **004**) After an audible alarm, the bell or siren will stop once the partition is disarmed or when the Bell Cut-Off Timer has elapsed. Enter any value between 001 and 255 minutes:

| | | | |
|---------------------|---------------------|---------------------|---------------------|
| Partition 1: [3113] | Partition 3: [3313] | Partition 5: [3513] | Partition 7: [3713] |
| Partition 2: [3213] | Partition 4: [3413] | Partition 6: [3613] | Partition 8: [3813] |

9.2.1 No Bell Cut-Off on Fire Alarm

SECTION [3030]: OPTION [2]

(default = **disabled**) The control panel can disable the Bell Cut-Off Timers when alarms are generated from zones defined as Standard or Delayed Fire Zones (see section 4.4 on page 33). The BELL output will remain enabled until a user disarms the partition in alarm.

9.2.2 Recycle Alarm Rate

(default = **000**) The control panel re-verifies the zone status during an alarm at a programmed rate once the Bell Cut-Off Timer and the Recycle Delay elapse. If open zones remain, the control panel will regenerate the alarm. Enter the number of times from 001 to 255 (000 = no limit) in one armed period that the control panel will re-verify the zone status:

| | | | |
|---------------------|---------------------|---------------------|---------------------|
| Partition 1: [3117] | Partition 3: [3317] | Partition 5: [3517] | Partition 7: [3717] |
| Partition 2: [3217] | Partition 4: [3417] | Partition 6: [3617] | Partition 8: [3817] |

9.2.3 Recycle Delay

(default = **000**) The Recycle Delay is the amount of time the control panel will wait after the Bell Cut-off occurs before re-verifying the zone status. Program the Recycle Delay from 001 to 255 minutes (000 = disabled):

| | | | |
|---------------------|---------------------|---------------------|---------------------|
| Partition 1: [3116] | Partition 3: [3316] | Partition 5: [3516] | Partition 7: [3716] |
| Partition 2: [3216] | Partition 4: [3416] | Partition 6: [3616] | Partition 8: [3816] |

9.3 Wireless Transmitter Supervision Options

SECTION [3034]: OPTIONS [1] AND [2]

When the control panel detects a Supervision Loss, the control panel can generate an alarm and/or trouble, unless the Wireless Transmitter Supervision Option is disabled.

 The Supervision feature must be enabled in the Magellan Wireless System (MG-RTX3) for this feature to function.

| | |
|---------|--------------------|
| [1] [2] | Description |
|---------|--------------------|

| | | |
|-----|-----|--|
| OFF | OFF | Disabled (default): Displays zone open on the keypads, but will not generate an alarm or trouble. <i>Not permitted on UL systems.</i> |
| OFF | ON | Generates Trouble Only (when armed or disarmed): The control panel displays <i>Zone Fault</i> in the Trouble Display and transmits the defined report code (see <i>section 10.2</i> on page 67). |
| ON | OFF | When disarmed: Generates Trouble Only The control panel displays <i>Zone Fault</i> in the Trouble Display and transmits the defined report code (see <i>section 10.2</i> on page 67). When armed: Follows Zone Alarm Type The control panel follows the zone's alarm type (<i>section 4.6.5</i> on page 36). |
| ON | ON | When disarmed: Generates Audible Alarm The control panel displays <i>Zone Fault</i> in the Trouble Display, transmits the defined report code (see <i>section 10.2</i> on page 67), and generates an audible alarm. When armed: Follows Zone Alarm Type The control panel follows the zone's alarm type (<i>section 4.6.5</i> on page 36). |

9.3.1 Supervision Bypass Options

SECTION [3034]: OPTION [3]

(default = **disabled**) When enabled in section [3034], the Wireless Transmitter Supervision Options will follow the zone's bypass definition. The control panel will not perform any action if a supervision loss occurs on a bypassed zone. When disabled, it will ignore the bypass definition and will follow the option set in *section 9.3*.

9.4 Police Code Timer

(default = **000**) If an alarm condition occurs on a zone, the control panel generates an alarm and triggers the Police Code Timer. The Police Code programmed in [3934] will only be sent if one of the following conditions occurs during the delay:

1. An alarm occurs on another zone.
2. The zone in alarm restores and reoccurs.

Key in the desired 3-digit delay value (001 to 255 minutes, 000 = disabled) into the section corresponding to the desired partition:

| | | | |
|---------------------|---------------------|---------------------|---------------------|
| Partition 1: [3118] | Partition 3: [3318] | Partition 5: [3518] | Partition 7: [3718] |
| Partition 2: [3218] | Partition 4: [3418] | Partition 6: [3618] | Partition 8: [3818] |

Refer to *Intellizone Options* on page 38 to set it up so that a police code is only generated on Zone Crossing.

9.5 Tamper Recognition Options

Note: Set the tamper to a 24hr Zone

SECTION [3034]: OPTIONS [5] AND [6]

When the control panel detects a tamper or wire fault on a zone or on an expansion module, the control panel can generate an alarm and/or trouble, as shown in the table below.

| [5] | [6] | Description |
|-----|-----|-------------|
|-----|-----|-------------|

| | | |
|-----|-----|--|
| OFF | OFF | Disabled (default): Displays zone open on the keypads, but will not generate an alarm or trouble. <i>Not permitted on UL systems.</i> |
| OFF | ON | Generates Trouble Only (when armed or disarmed): The control panel displays <i>Zone Fault</i> in the Trouble Display and transmits the defined report code (see <i>section 10.2</i> on page 67). |
| ON | OFF | When disarmed: Generates Trouble Only The control panel displays <i>Zone Fault</i> in the Trouble Display and transmits the defined report code (see <i>section 10.2</i> on page 67). When armed: Follows Zone Alarm Type The control panel follows the zone's alarm type (<i>section 4.6.5</i> on page 36). |
| ON | ON | When disarmed: Generates Audible Alarm The control panel displays <i>Zone Fault</i> in the Trouble Display, transmits the defined report code (see <i>section 10.2</i> on page 67), and generates an audible alarm. When armed: Follows Zone Alarm Type The control panel follows the zone's alarm type (<i>section 4.6.5</i> on page 36). |

9.5.1 Tamper Bypass Options



SECTION [3034]: OPTION [7]

(default = **enabled**) When enabled in section [3034], the control panel will ignore the zone's bypass definition and will follow the option set in *section 9.5* (page 62) if a tamper or wire fault occurs on a bypassed zone. When disabled, Tamper Recognition follows the zone's bypass definition. This means that the control panel will not perform any action if a tamper or wire fault occurs on a bypassed zone.

9.6 Keypad Panic Options

(default = **disabled**) The control panel can generate an alarm (audible, fire or report only) by pressing the keypad Panic key(s). Refer to the table below for the keypad Panic keys. In the section that corresponds to the desired partition, enable or disable options [1] through [6]:

| | | | |
|---------------------|---------------------|---------------------|---------------------|
| Partition 1: [3123] | Partition 3: [3323] | Partition 5: [3523] | Partition 7: [3723] |
| Partition 2: [3223] | Partition 4: [3423] | Partition 6: [3623] | Partition 8: [3823] |

| Option | Feature | Press and Hold 2 Seconds: |
|--------|----------|--|
| [1] | Panic 1* | LCD keypads: Keys [1] and [3] simultaneously Grafica keypads: The  key |
| [2] | Panic 2* | LCD keypads: Keys [4] and [6] simultaneously Grafica keypads: The  key |
| [3] | Panic 3 | LCD keypads: Keys [7] and [9] simultaneously Grafica keypads: The  key |

| Option | Alarm Type |
|--------|--|
| [4] | Panic 1:* ON = Audible OFF = Report Only |
| [5] | Panic 2:* ON = Audible OFF = Report Only |
| [6] | Panic 3: ON = Fire OFF = Report Only |

Report Only

The keypad emits a single confirmation beep and transmits the report code.

Audible Alarm

The control panel activates the BELL output until a user cancels the alarm or when the Bell Cut-Off Timer elapses .

Fire Alarm

Same as audible operation, except that the bell/siren output will be pulsed.

** **UL Note:** For UL Listed systems, all emergency non-medical and auxiliary panic alarms will be report only.*

Figure 19: Event Reporting

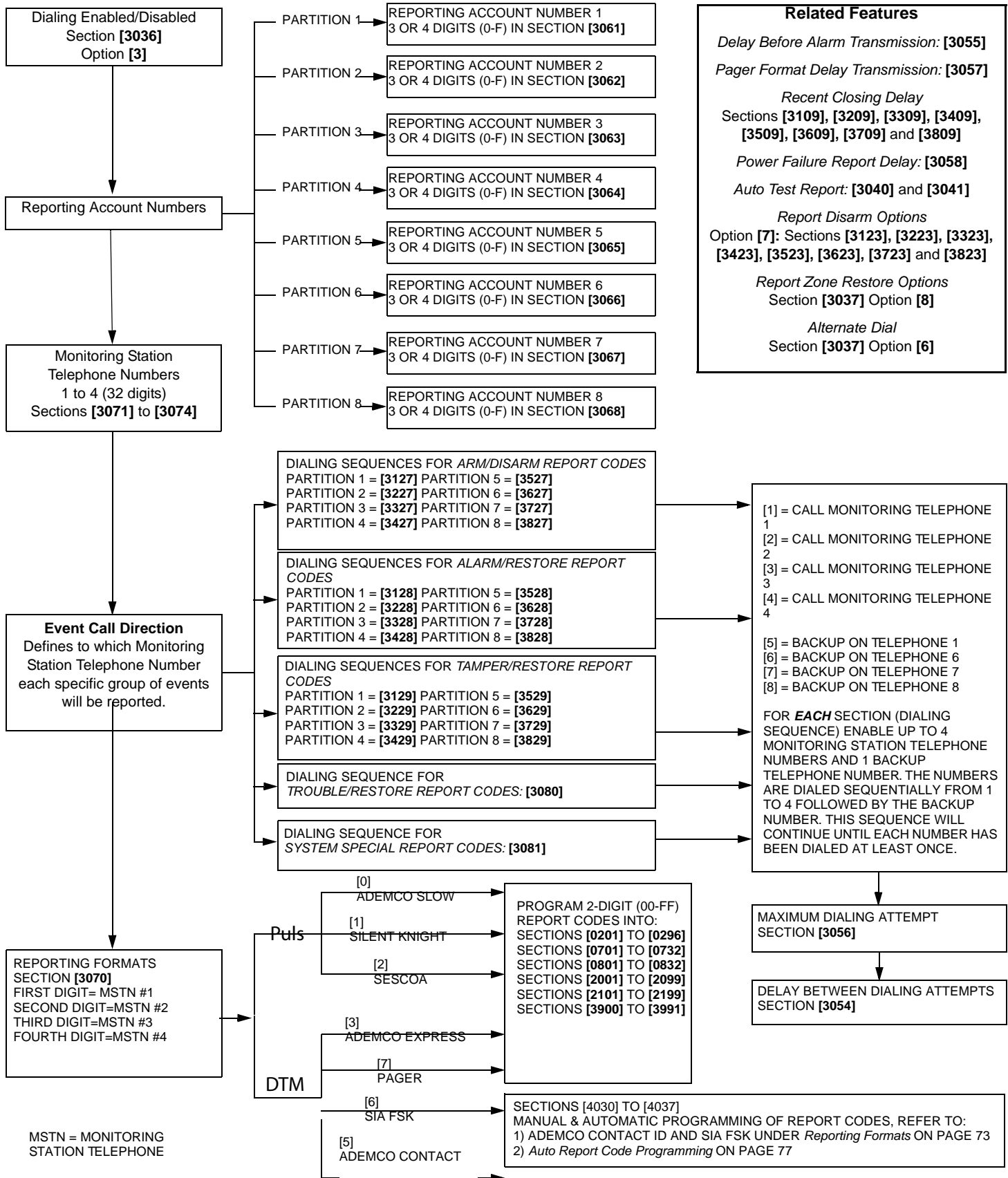

MSTN = MONITORING STATION TELEPHONE

10.1 Reporting Enabled

Note: The phone line between the protected property and the communications service provider shall be for the exclusive use of the protected property and is not to be shared with other communications service provider subscribers.

Note: Do NOT program this system or any of its modules to automatically place a call to a police station number that has not been specifically assigned by that police station for such a service.

SECTION [3036]: OPTION [3]

(default = **disabled**) If enabled, the control panel verifies if a report code was programmed in the section corresponding to event that happened. If a report code is programmed, the control panel dials the monitoring station telephone number. When the monitoring station answers, the control panel transmits the system account code and the programmed report code.

10.2 Report Codes

Report codes are 2-digit or 1-digit hexadecimal value. The Ademco Slow, Silent Knight, SESCOA and Pager Formats support 1-digit report codes. The transmission is defined by these two items: **Reporting Formats** (see *section 10.7* on page 73) and **Event Call Direction** (see *section 10.8* on page 74). If you are using the Ademco CID or SIA formats, an Auto Report Code Programming feature is available (see *section 10.17* on page 77).

10.2.1 Zone Alarm and Alarm Restore Report Codes

SECTION [0400]: FIRST AND SECOND BRACKETS

SECTIONS [0201] TO [0296]: FIRST AND SECOND BRACKETS

The first set of 2 digits in the sections refer to the Alarm Report Codes that identify which zones generated an alarm. The second set of 2 digits refer to the Alarm Restore Report Codes when a zone closes or once the bell has cut-off (see *section 9.2* on page 61). Refer to Zone Restore Report Options in.

10.2.2 Tamper and Tamper Restore Report Codes

section [0400]: Third and Fourth Brackets

SECTIONS [0201] TO [0296]: THIRD AND FOURTH BRACKETS

The third set of 2 digits refer to the Tamper Report Codes. The fourth set of 2 digits refer to the Tamper Restore Report Codes.

10.2.3 Keyswitch Arming

SECTIONS [0701] TO [0732]

Each section from **[0701]** to **[0732]** corresponds to a keyswitch from 1 to 32. The control panel can send the report code to the monitoring station identifying which keyswitch was used to arm. It will not send report codes for keyswitches that are defined with the PGM Activation definition.

10.2.4 Keyswitch Disarming

SECTIONS [0801] TO [0832]

Each section from **[0801]** to **[0832]** corresponds to a keyswitch from 1 to 32. The control panel can send a report code to the monitoring station identifying which keyswitch was used to disarm. It can transmit the report codes every time a partition is disarmed or only following an alarm. It will not send report codes for keyswitches that are defined with the PGM Activation definition.

10.2.5 Access Codes Arming

SECTIONS [2001] TO [2099]

A report code can be programmed for each user access code from 01 to 98 in sections **[2001]** to **[2098]**. User access codes from 99 to 999 use a common report code in section **[2099]**. The control panel can send the report code identifying which access code was used to arm the system.

10.2.6 Access Codes Disarming

SECTIONS [2101] TO [2199]

A report code can be programmed for each user access code from 01 to 98 in sections **[2101]** to **[2198]**. User access codes from 99 to 999 use a common report code programmed in section **[2199]**. The control panel can send the report code to the monitoring station identifying which access code was used to disarm the system. It can be transmitted when a partition is disarmed or only following an alarm.

10.2.7 Special System Reporting Codes

When the system generates one of the following events, the control panel can send the report code to the monitoring station identifying the event:

| | | |
|-------------------------|-----------------------|---|
| [3900] | Cold Start | control panel re-starts after complete shutdown (total power loss) |
| [3901] | Warm Start | control panel resets due to sudden problem other than power loss |
| [3902] | Test Report | report generated automatically (see <i>section 10.14</i>) |
| [3903] | Listen-In to Follow | Listen-In module attempts to start a Listen-In session |
| [3904] | WinLoad Login Request | communication attempted between WinLoad and control panel (Callback only) |
| [3905] | WinLoad Log Off | control panel ends communication with WinLoad |
| [3906] | Installer In | installer enters programming mode |
| [3907] | Installer Out | installer exits programming mode |
| [3908] to [3909] | | Future Use |

10.2.8 Special Arming Report Codes

When the partition arms using a special arming feature, the control panel can send the report code identifying how the system was armed.

| | | |
|---------------|----------------|---|
| [3910] | Auto-Arming | when Auto-Arming (see <i>section 8.10</i> on page 56) |
| [3911] | PC Arming | system armed using WinLoad or NEware software |
| [3912] | Late to Close | when Auto-Arming (see <i>section 8.10</i> on page 56) |
| [3913] | No Movement | when No Movement Auto-Arming (see <i>section 8.11</i> on page 56) |
| [3914] | Partial Arming | when partitions are Stay, Instant or Force armed or armed with bypassed zones |
| [3915] | Quick Arming | partitions armed with a One-Touch Arming feature (see <i>section 8.17</i> on page 58) |
| [3916] | Early to Close | partition armed before Arming Report Schedule (see <i>section 10.3.1</i> on page 71) |
| [3917] | Late to Close | partition armed after Arming Report Schedule (see <i>section 10.3.1</i> on page 71) |
| [3918] | Remote Arm | partition armed with the InTouch Voice-Assisted Arm/Disarm Module (APR3-ADM2) |

| | | |
|---------------|---------------------|--|
| [3919] | Closing Delinquency | Partition hasn't been armed before the programmed Closing Delinquency Timer elapsed (see <i>section 10.18</i> on page 77). |
|---------------|---------------------|--|

10.2.9 Special Disarming Report Codes

When using one of the special disarming features listed below, the control panel can send the report code identifying how the system was disarmed. Also, refer to *Disarm Reporting Options*.

| | | |
|---------------|-----------------------|---|
| [3920] | Cancel Auto-Arm | partition disarms during the Auto-Arm's delay (see <i>section 8.10</i> on page 56) |
| [3921] | Quick Disarm | partition disarms using One-Touch Disarming feature (see <i>section 8.17</i> on page 58) |
| [3922] | PC Disarm | system disarmed using WinLoad or NEware software |
| [3923] | PC Disarm after Alarm | system disarmed using WinLoad or NEware software after an alarm occurs |
| [3924] | Cancel Alarm | indicates that an alarm was cancelled even though the system was not armed when the alarm occurred. |
| [3925] | Future Use | |
| [3926] | Early to Open | partition disarmed before Disarming Schedule (see <i>section 10.3.1</i> on page 71) |
| [3927] | Late to Open | partition disarmed after Disarming Schedule (see <i>section 10.3.1</i> on page 71) |
| [3928] | Remote Disarm | partition disarmed with InTouch Voice-Assisted Arm/Disarm Module (APR3-ADM2) |

10.2.10 Special Alarm Report Codes

| | | |
|--------|-------------------------------|--|
| [3930] | Emergency Panic (non-medical) | the panic keys [1] and [3] were pressed (see <i>section 9.6</i> on page 63) |
| [3931] | Auxiliary Panic | the panic keys [4] and [6] were pressed (see <i>section 9.6</i> on page 63) |
| [3932] | Fire Panic | the panic keys [7] and [9] were pressed (see <i>section 9.6</i> on page 63) |
| [3933] | Recent Closing | an alarm is generated within the <i>Recent Close Delay</i> (see <i>section 10.10</i> on page 75) |
| [3934] | Police Code | Confirmation of an alarm condition occurred during the Police Code Timer's delay (see <i>section 9.4</i> on page 62). |
| [3935] | Auto Zone Shutdown | the control panel stops regenerating alarms on a zone during the same armed period (see <i>section 4.6.1</i> on page 35) |
| [3936] | Duress | a Duress enabled access code is keyed in (see <i>Keypad Installation Instructions</i> on page 106) |
| [3937] | Keypad Lockout | too many invalid codes entered (see <i>section 8.19</i> on page 59) |

10.2.11 System Trouble Codes

| | | |
|------------------|-------------------------------------|--|
| [3941] | AC Failure | AC power not detected. Also, see Power Fail Report Delay in <i>section 10.11</i> |
| [3942] | Battery Failure | battery is disconnected or the battery voltage is less than or equal to 10.5V |
| [3943] | Auxiliary Supply | the aux power supply's current is greater than or equal to 1.1A |
| [3944] | Bell Output | bell output is disconnected or the current is greater than or equal to 3A |
| [3945] | Clock Loss | panel time lost (see <i>section 14.17</i>) |
| [3946] | Fire Loop Trouble | tamper on a Fire Zone (see <i>section 4.4</i>) |
| [3947] to [3949] | | Future Use |
| [3950] | Bus Fault | a module was removed from the combus |
| [3951] | Module Tamper | tamper/wire fault on module (not a motion detector) on the combus |
| [3952] | ROM Check Error | on-board Read-Only Memory trouble |
| [3953] | Module TLM | TLM failure detected on Listen-In Module (DGP-LSN4) |
| [3954] | Module Fail to Communicate | DGP2-DVAC failed to communicate with the monitoring station |
| [3955] | Printer Fault | Printer Module detected an error |
| [3956] | Module AC Failure | no AC power detected on a module |
| [3957] | Module Battery Failure | battery on a module is disconnected or the battery voltage is low |
| [3958] | Module Auxiliary Failure | the AUX output on a module has exceeded current limits |
| [3959] | | Future Use |
| [3960] | Wireless Trans-mitter Low Battery | the battery voltage is low on a wireless transmitter |
| [3961] | Wireless Module Supervision Failure | this report code is global unless using the Contact ID or SIA reporting formats |
| [3962] to [3964] | | Future Use |
| [3965] | Fail to Com 1 | Phone Number 1 failed to communicate* |
| [3966] | Fail to Com 2 | Phone Number 2 failed to communicate* |
| [3967] | Fail to Com 3 | Phone Number 3 failed to communicate* |
| [3968] | Fail to Com 4 | Phone Number 4 failed to communicate* |

* No "Fail to Communicate" for Pager telephone numbers

10.2.12 System Trouble Restore Codes

| | | | |
|--------|---------------------------|--------|---------------------------------------|
| [3970] | TLM1 Restored | [3981] | Module Tamper Restored |
| [3971] | AC Restored | [3982] | ROM Check Error Restored |
| [3972] | Battery Restored | [3983] | Module TLM Restored |
| [3973] | Auxiliary Supply Restored | [3984] | Module Fail to Communicate Restored |
| [3974] | Bell Output Restored | [3985] | Printer Fault Restored |
| [3975] | Clock Loss Restored | [3986] | Module AC Failure Restored |
| [3976] | Fire Loop Restored | [3987] | Module Battery Restored |
| [3977] | Future Use | [3988] | Module Auxiliary Restored |
| [3978] | Future Use | [3989] | Future Use |
| [3979] | Future Use | [3990] | Wireless Transmitter Battery Restored |
| [3980] | Bus Fault Restored | [3991] | Wireless Module Supervision Restored |

⚠ If the Telephone Line Monitoring (see section 11.1) is disabled, the control panel will not transmit the TLM report code.

10.3 Report Arming and Disarming

These features identify when partitions should be armed or disarmed. It allow the control panel to report changes from the schedule.

10.3.1 Arming and Disarming Report Schedules

Arming and Disarming Report Schedules identify the days and times that a partition should be armed and disarmed. Each schedule consists of 2 programmable time periods called Intervals that determine the time span and days when the partition should be armed or disarmed (see *Figure 20*). Schedules are enabled when they are programmed.

Figure 20: Example of an Arming and a Disarming Report Schedule

Section [3102]: Arming Schedule (partition 1)
Interval 1: Start Time 16:55 End Time 17:30 Options 2, 3, 4, 5 & 6

Section [3103]: Disarming Schedule (partition 1)
Interval 1: Start Time 08:50 End Time 09:10 Options 2, 3, 4, 5, 6

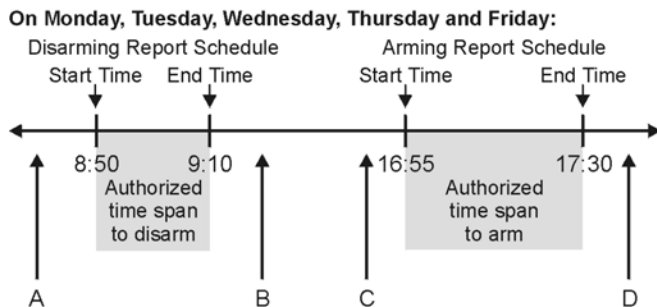

- A = If partition is disarmed, Early to Open report code sent.
- B = If partition is disarmed, Late to Open report code sent.
- C = If partition is armed, Early to Close report code sent.
- D = If partition is armed, Late to Close report code sent.

Program the Start Time and End Time according to the 24-hour clock and enable the options representing the desired Days for the desired partition. When option [8] is enabled, access is permitted during the programmed holidays.

Arming Report Schedule

| | | | |
|---------------------|---------------------|---------------------|---------------------|
| Partition 1: [3102] | Partition 3: [3302] | Partition 5: [3502] | Partition 7: [3702] |
| Partition 2: [3202] | Partition 4: [3402] | Partition 6: [3602] | Partition 8: [3802] |

Disarming Report Schedule

| | | | |
|---------------------|---------------------|---------------------|---------------------|
| Partition 1: [3103] | Partition 3: [3303] | Partition 5: [3503] | Partition 7: [3703] |
| Partition 2: [3203] | Partition 4: [3403] | Partition 6: [3603] | Partition 8: [3803] |

| Option | Day | Option | Day |
|--------|---------------|--------|--------------|
| [1] | Sunday (S) | [5] | Thursday (T) |
| [2] | Monday (M) | [6] | Friday (F) |
| [3] | Tuesday (T) | [7] | Saturday (S) |
| [4] | Wednesday (W) | [8] | Holidays (H) |

10.3.2 Arming/Disarming Schedule Tolerance Window

(default = 000) The Arming/Disarming Schedule Tolerance Window lengthens the partition's Arming/Disarming Schedule for some users. User access codes with Add Tolerance Windows to Schedules enabled have the number of minutes programmed in these sections added before and after the corresponding partition's schedule. Enter any value between 001 and 255 to determine Arming/Disarming Schedule Tolerance Window in minutes.

| | | | |
|---------------------|---------------------|---------------------|---------------------|
| Partition 1: [3104] | Partition 3: [3304] | Partition 5: [3504] | Partition 7: [3704] |
| Partition 2: [3204] | Partition 4: [3404] | Partition 6: [3604] | Partition 8: [3804] |



The Arming/Disarming Schedule Tolerance Window applies to the Arming and Disarming Report Schedules only (section 10.3.1). The Arming/Disarming Schedule Tolerance Window does not apply to Access Schedules.

10.4 Monitoring Station Phone Number

SECTIONS [3071] TO [3074]

The control panel can dial up to 4 different monitoring station telephone numbers. Sections [3071] to [3074] represent monitoring station telephone numbers 1 through 4. Enter any digit up to a maximum of 32.

Table 4: Special Telephone Number Keys

| Functions | Key | |
|-------------------------------|----------|--|
| * | [STAY] | [#] (Press the key until the desired letter/symbol appears) |
| # | [FORCE] | |
| Switch to Tone Dialing (T) | [ARM] | |
| Wait for second dial tone (W) | [DISARM] | |
| 4-second pause (P) | [BYP] | |
| Insert | [MEM] | — |
| Delete | [TRBL] | — |
| Delete from cursor to end | [ACC] | Left action key (Clear) |

Note: The phone line between the protected property and the communications service provider shall be for the exclusive use of the protected property and is not to be shared with other communications service provider subscribers.

Note: Do NOT program this system or any of its modules to automatically place a call to a police station number that has not been specifically assigned by that police station for such a service.

10.5 Account Number

SECTIONS [3061] TO [3068]

(default = **000**) All report codes are preceded by a 3- or 4-digit Account Number to ensure correct identification of system events. Account Numbers can be any hexadecimal value from 0 to F.

Table 5: Account Numbers

| Section | Account Number | Section [3035], option [6] = disabled | Section [3035], option [6] = enabled |
|---------|------------------|---------------------------------------|--------------------------------------|
| [3061] | Account Number 1 | Partition 1 | MSTN 1 |
| [3062] | Account Number 2 | Partition 2 | MSTN 2 |
| [3063] | Account Number 3 | Partition 3 | MSTN 3 |
| [3064] | Account Number 4 | Partition 4 | MSTN 4 |
| [3065] | Account Number 5 | Partition 5 | N/A |
| [3066] | Account Number 6 | Partition 6 | N/A |
| [3067] | Account Number 7 | Partition 7 | N/A |
| [3068] | Account Number 8 | Partition 8 | N/A |

 **Only the SIA format supports the [0] = 0 digit in its account numbers. Account numbers that use other reporting formats do not support the [0] = 0 digit. Enter the [STAY] = A digit in its place. When using the SIA Format, and the Account Number Transmission (see section 10.6 on page 73) corresponds to the partition, the control panel only uses the Partition 1 Account Number programmed in section [3061], but the report code includes the partition number.**

10.6 Account Number Transmission

SECTION [3035]: OPTION [6]

(default = **Partition Account #**) When enabled, the account number corresponding to the MSTN that was dialed will be sent regardless of which partition the report originated from. When disabled, the account number that is sent to the monitoring station corresponds to the partition where the event originated, regardless of which MSTN is dialed.

10.7 Reporting Formats

SECTION [3070]

The control panel can use a number of different reporting formats. Each monitoring station phone numbers should be programmed with the same reporting format unless they are combined with a Pager format. The first digit represents the reporting format (see Table 6) used for Monitoring Station Telephone Number 1, the second digit, Monitoring Station Telephone Number 2, etc.

Compatible Digital Alarm Communication Receivers (DACRs):*

- Sur-Gard DRL2A
- Ademco 685
- Osborne Hoffman Quick Alert II

Table 6: Reporting Formats*

| | |
|--|-----------------------|
| 0 = Ademco slow (1400Hz, 1900Hz, 10BPS) | 4 = Contact ID Pager |
| 1 = Silent Knight fast (1400Hz, 1900Hz, 20BPS) | 5 = Ademco Contact ID |
| 2 = SESCOA (2300Hz, 1800Hz, 20BPS) | 6 = SIA FSK |

* **UL Note:** *Installer must verify the compatibility with of the DACR. Use listed compatible DACRs.*

10.7.1 Standard Pulse Formats

The control panel can use the Ademco slow, Silent Knight fast and SESCOA standard pulse reporting formats (see Table 6).

10.7.2 Ademco Express

The Ademco Express is a high-speed reporting format that communicates 2-digit (00 to FF) report codes. The Ademco Express does not use the Contact ID Report Codes.

10.7.3 Contact ID Pager

The control panel will transmit a Contact ID report instead of a user generated numerical code to a pager. The Contact ID report code will come from either the *Automatic Report Code List* on page 101 or the *Contact ID Report Code List* on page 104.

10.7.4 Ademco Contact ID

Ademco Contact ID is a fast communicator format that uses tone reporting. To program the report codes, use the 2-digit hexadecimal values from the *Contact ID Report Codes List* in the "EVO Programming Guide". Enter 00 to disable reporting or FF to use the default report code from the *Automatic Report Code List* in the "EVO Programming Guide". To program a set of default Contact ID codes, refer to see *section 10.17* on page 77.

10.7.5 SIA FSK

SIA FSK is a fast communicator format that uses tone reporting. To program the report codes, enter 00 to disable reporting or any other value to use the default report code from the *Automatic Report Code List* in the "EVO Programming Guide". To program a set of default SIA FSK codes, refer to *Auto Report Code Programming* on page 77.

10.7.6 Pager Reporting Format

Using this format allows the control panel to transmit report codes to a pager. A pound symbol "#" is automatically generated after the report code.

10.8 Event Call Direction

Event groups can be programmed to dial up to four monitoring station telephone numbers with one used as a backup. The numbers are dialed sequentially, skipping any disabled numbers and stopping once all selected telephone numbers have been reached. If the control panel still fails to report to a monitoring station telephone number after reaching the Maximum Dialing Attempts (see *section 10.8.1* on page 75), the control panel will dial the selected backup telephone number. For each section enable or disable the options:

| |
|--|
| Troubles and Restore Troubles: [3080] |
| Special System, Arming, Disarming and Alarm Reporting: [3081] |

Access Code and Keyswitch Arming and Disarming

| | | | |
|----------------------------|----------------------------|----------------------------|----------------------------|
| Partition 1: [3127] | Partition 3: [3327] | Partition 5: [3527] | Partition 7: [3727] |
| Partition 2: [3227] | Partition 4: [3427] | Partition 6: [3627] | Partition 8: [3827] |

Zone Alarms and Alarm Restores

| | | | |
|----------------------------|----------------------------|----------------------------|----------------------------|
| Partition 1: [3128] | Partition 3: [3328] | Partition 5: [3528] | Partition 7: [3728] |
| Partition 2: [3228] | Partition 4: [3428] | Partition 6: [3628] | Partition 8: [3828] |

Tampers and Tamper Restores

| | | | |
|----------------------------|----------------------------|----------------------------|----------------------------|
| Partition 1: [3129] | Partition 3: [3329] | Partition 5: [3529] | Partition 7: [3729] |
|----------------------------|----------------------------|----------------------------|----------------------------|

| | | | |
|---------------------|---------------------|---------------------|---------------------|
| Partition 2: [3229] | Partition 4: [3429] | Partition 6: [3629] | Partition 8: [3829] |
|---------------------|---------------------|---------------------|---------------------|

(default = **only option [1] enabled**)

| Option | Call: | Option | Call (select one only): |
|--------|--------------------|--------|-------------------------|
| [1] | Telephone Number 1 | [5] | Backup on Number 1 |
| [2] | Telephone Number 2 | [6] | Backup on Number 2 |
| [3] | Telephone Number 3 | [7] | Backup on Number 3 |
| [4] | Telephone Number 4 | [8] | Backup on Number 4 |

10.8.1 Maximum Dialing Attempts*

SECTION [3056]

(default = **008**) The number (001 to 255, 000 = 8 attempts) programmed into section [3056] determines how many tries before proceeding to the next number. Also refer to *section 10.8.3*.

* **UL Note:** For UL Listed systems, the maximum dialing attempts must be set to 5 to 10 attempts between the EVO's two telephone lines.

10.8.2 Delay Between Dialing Attempts

SECTION [3054]

(default = **020**) This delay can be set from 001 to 127 seconds.

10.8.3 Alternate Dialing Option

SECTION [3037]: OPTION [6]

(default = **disabled**) When enabled, the control panel dials the selected backup telephone number after every failed attempt to contact a monitoring station telephone number. When disabled, the control panel dials the backup telephone number after the Maximum Dialing Attempts (see *section 10.8.1*) to one monitoring station telephone number fail.

10.9 Pager Delay

SECTION [3057]

(default = **020**) When using the Pager Reporting Format (see *section 10.7.6*), the control panel will wait for the delay period programmed into section [3057] before uploading the report codes to the pager. Enter any value between 001 and 127 to determine Pager Delay in seconds.

10.10 Recent Close Delay

(default = **000**) If an alarm is generated within the programmed period after arming the partition, the control panel will transmit the *Recent Close* report code programmed into section [3933]. Enter any value between 001 and 255 to determine Recent Close Delay in seconds.

| | | | |
|---------------------|---------------------|---------------------|---------------------|
| Partition 1: [3109] | Partition 3: [3309] | Partition 5: [3509] | Partition 7: [3709] |
| Partition 2: [3209] | Partition 4: [3409] | Partition 6: [3609] | Partition 8: [3809] |

10.11 Power Failure Report Delay

SECTION [3058]

(default = **030**) The control panel will delay the transmission of the *AC Failure* report code programmed into section [3941] by the period programmed into section [3058]. Enter any value between 001 and 255 to determine Power Failure Report Delay in minutes.

10.12 Power Failure Restore Report Delay

SECTION [3060]

(default = **030**) The control panel will delay the transmission of the *AC Failure Restore* report code programmed into section [3972] by the period programmed into section [3060]. Enter any value between 001 and 255 to determine Power Failure Restore Report Delay in minutes.

10.13 Repeat Pager Report Code Transmission

SECTION [3059]

{default = **000**} This feature re-sends the report code as specified.

10.14 Auto Test Report

SECTION [3037]: OPTIONS [3] AND [4] AND

SECTIONS [3040], [3041], [3042] AND [3043]

The control panel can transmit the test report code programmed into section [3902] every hour or after a period of time.

| | | | |
|-----|-----|---|--|
| OFF | OFF | Auto Test Report Period (default) | After the number programmed (000 to 255 days, default = 000) in section [3040], the control panel transmits a report code at the time (00:00 to 23:59, default = 00:00) programmed in section [3041]. |
| OFF | ON | Timed Test Transmission when Armed/Disarmed | When disarmed: The control panel transmits the code at regular intervals. Program the number of minutes (000 to 255, default = 060) between transmissions in section [3043]. When armed: The control panel transmits the test report code at regular intervals. Program the number of minutes (000 to 255, default = 005) between each transmission in section [3042]. |
| ON | OFF | Hourly Test Transmission | The control panel will transmit the test report code every hour on the minute value programmed in section [3041] (the last two digits). Note that the first two digits of section [3041] will be ignored. |
| ON | ON | Timed and Hourly Test Transmission | The test report code will be transmitted when any of the conditions of the second and third options listed above (options [3] = OFF and [4] = ON / options [3] = ON and [4] = OFF) are met. |

10.15 Disarm Reporting Options

(default = **disabled**) When disabled, the control panel sends the Disarming Report Codes every time the partition is disarmed. When enabled, the control panel sends the Disarming Report Codes to the monitoring station only when the partition is disarmed following an alarm. Select the section that corresponds to the desired partition and enable or disable option [7]:

| | | | |
|---------------------|---------------------|---------------------|---------------------|
| Partition 1: [3123] | Partition 3: [3323] | Partition 5: [3523] | Partition 7: [3723] |
| Partition 2: [3223] | Partition 4: [3423] | Partition 6: [3623] | Partition 8: [3823] |

10.16 Zone Restore Report Options

SECTION [3037]: OPTION [8]

(default = **disabled**) When disabled, the control panel sends the *Zone Alarm Restore* report codes to the monitoring station when the Bell Cut-Off Timer elapses (see section 9.2) or when the alarm is disarmed. When enabled, the control panel sends the *Zone Alarm Restore* report codes (see section 10.2) to the monitoring station as soon as the zone returns to normal (zone closure) or upon disarming.

10.17 Auto Report Code Programming

When using either the Contact ID or SIA Reporting Formats (see *section 10.7* on page 73), the control panel can automatically program a set of default report codes. The Contact ID Reporting Format can be modified using the manual programming method (see *section 10.7.4* & see *section 10.7.5* on page 74) to program remaining report codes or to change some of the defaults. Enter any of the following sections to set the indicated report codes with the default values (FF) from the *Automatic Report Codes List* in the "EVO Programming Guide":

| Section | Description |
|---------|--|
| [4030] | Resets all the report code sections to 00 (cleared). |
| [4031] | Sets all the report code sections to FF (defaults). |

| Section | Sets to Defaults (FF) | Reset Sections |
|---------|--|--|
| [4032] | Zone Alarm and Restore Report Codes Tamper and Restore Report Codes | [0201] to [0296] |
| [4033] | Keyswitch Arming Report Codes Keyswitch Disarming Report Codes Access Code Arming Report Codes Access Code Disarming Report Codes | [0701] to [0732] [0801] to [0832] [2001] to [2099] [2101] to [2199] |
| [4034] | Special System Report Codes | [3900] to [3909] |
| [4035] | Special Arming Report Codes Special Disarming Report Codes | [3910] to [3919] [3920] to [3929] |
| [4036] | Special Alarm Report Codes | [3930] to [3939] |
| [4037] | Trouble and Restore Report Codes | [3940] to [3991] |

10.18 Closing Delinquency Timer

(default = **000**; disabled) When a partition in the system is disarmed, the control panel will start the corresponding partition's Closing Delinquency Timer. If the Closing Delinquency Timer elapses before the partition is armed again, EVO will transmit a "Closing Delinquency" report code to the monitoring station. Enter a value from 001 to 255 days into the appropriate section. Enter 000 to disable the Closing Delinquency Timer.

| | | | |
|---------------------|---------------------|---------------------|---------------------|
| Partition 1: [3119] | Partition 3: [3319] | Partition 5: [3519] | Partition 7: [3719] |
| Partition 2: [3219] | Partition 4: [3419] | Partition 6: [3619] | Partition 8: [3819] |

11.1 Telephone Line Monitoring

SECTION [3036]: OPTIONS [1] AND [2]

When enabled, the system verifies the existence of the main telephone line once every second. After each successful test, the Status LED on the control panel flashes briefly. A line test failure occurs when the TLM detects less than 3 volts for the period defined by the TLM Fail Timer (see *section 11.1.1*). If the line test fails, the control panel will generate one or more conditions as defined by the TLM settings below, until it detects the telephone line again. When the dialer detects a telephone ring, the TLM test stops for 1 minute.

| [1] | [2] | Feature | When the line test fails |
|-----|-----|------------------------------|---|
| OFF | OFF | Disabled | TLM disabled (default) . |
| ON | OFF | Trouble Only | The <i>Communicator</i> trouble appears in the Trouble Display. |
| OFF | ON | Alarm when Armed | The <i>Communicator</i> trouble appears in the Trouble Display. If the partition is armed, the control panel generates an alarm. |
| ON | ON | Silent Alarms become Audible | The <i>Communicator</i> trouble appears in the Trouble Display. The control panel switches any triggered <i>Silent Alarm</i> zones or <i>Silent</i> panic alarms to an audible alarm. |

11.1.1 TLM Fail Timer

SECTION [3053]

(default = **016**) If the TLM does not detect the existence of the main telephone line for the time programmed in this section, the control panel will generate the condition(s) defined by the TLM options (see *section 11.1*). Enter any value between 016 and 255 (value is X2 seconds) into section [3053]. Entering a value between 000 and 016 will set the TLM Fail Timer to 32 seconds.

11.2 Tone/Pulse Dialing

SECTION [3036]: OPTION [4]

(default = **enabled**)

| | | |
|-----|-----|----------------------|
| [4] | ON | Tone/DTMF format |
| [4] | OFF | Pulse dialing format |

11.3 Pulse Ratio

SECTION [3036]: OPTION [5]

(default = **enabled**) When using Pulse dialing (see *section 11.2*), select one of two Pulse Ratios. If the selected pulse ratio does not provide adequate results, try the other one.

| | | |
|-----|-----|-------------------------------------|
| [5] | ON | North American pulse ratio of 1:1.5 |
| [5] | OFF | European pulse ratio of 1:2 |

11.4 Busy Tone Detection

SECTION [3036]: OPTION [6]

(default = **enabled**) When enabled, the control panel immediately hangs up if it receives a busy signal when it dials an outside number.

11.5 Switch To Pulse

SECTION [3036]: OPTION [7]

(default = **disabled**) When is enabled, the control panel switches from tone dialing to pulse dialing on the fifth attempt to report events to the monitoring station. The control panel continues to use pulse dialing until it establishes communication. When the control panel switches to another monitoring station telephone number, it returns to tone dialing and switches back to pulse dialing on the fifth attempt.

11.6 Bell On Communication Fail

SECTION [3036]: OPTION [8]

(default = **disabled**) When enabled and the control panel fails to communicate with the monitoring station when the partition is armed, the control panel can enable the BELL output.

11.7 Keypad Beep on Successful Arm or Disarm Report

SECTION [3037]: OPTION [5]

(default = **disabled**) When enabled and a user arms or disarms a partition, the keypad emits a beep tone to confirm that the monitoring station received the arming or disarming report code.

11.8 Dial Tone Delay

SECTION [3037]: OPTION [7]

(default = **disabled**)

| | | |
|-----|-----|--|
| [7] | ON | If no dial tone is present, dialer hangs up after 32 secs. |
| [7] | OFF | If no dial tone is present, force dials after 3 secs. |

If more time is required, insert a 4-second pause into the desired telephone number sequence (see *section 10.4*).

11.9 Call Waiting Cancel

1. Section 4.5 requires a programmable option for call waiting cancel shall be required on communicators that use media (e.g. PSTN) where call-waiting may be provisioned.

The programming for this feature must be added to the Programming Guide.

The installer needs to verify the code in the premises area for the telephone network that disables the call waiting feature, then add it to the monitoring station number.

For example:

Receiving center phone number: 999-999-999

Call waiting cancelation code: *70

Phone number to program: *70P999999999

) Instructions that an automatic telephone dialer or similar device shall not be set or programmed to place a call to a police station number that has not been specifically assigned by that police station for such service. The instructions may be incorporated on the inside of the product, on a separate sheet, or as part of a manual. If not included directly on the product, the instructions or manual shall be referenced in the marking information on the product. .

Note: Do NOT program this system or any of its modules to automatically place a call to a police station number that has not been specifically assigned by that police station for such a service.

The installation instructions shall state that the communication medium between protected property and communications service provider shall be for the exclusive use of the protected property and is not to be shared with other communications service provider subscribers

Note: The phone line between the protected property and the communications service provider shall be for the exclusive use of the protected property and is not to be shared with other communications service provider subscribers.

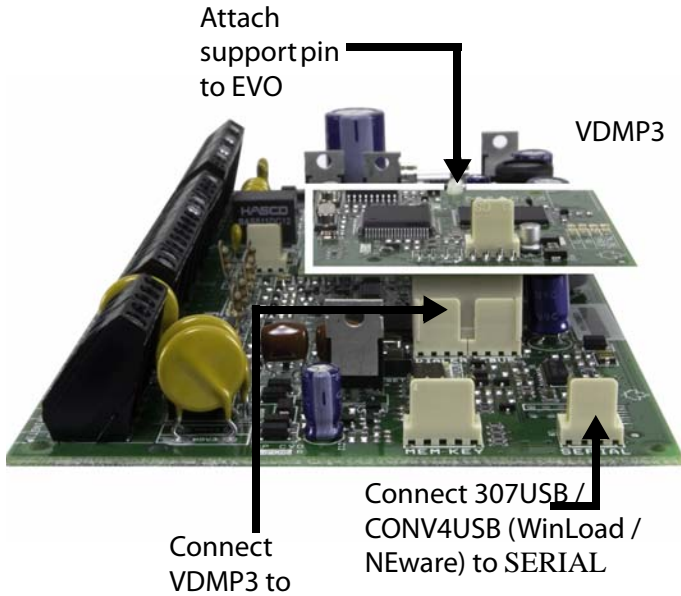

12.1 VDMP3 Installation Instructions

| Step | English |
|--------------|--|
| 1 Install | <ul style="list-style-type: none"> •Power down the EVO control panel. •Install the VDMP3 directly onto the EVO control panel's SERIAL and DIALER connectors as shown in "VDMP3 Installation Instructions"12.1. •If using a 307USB or CONV4USB, connect to the COM PORT connector as shown in "VDMP3 Installation Instructions"12.1. •Power up the EVO control panel. |

12.2 Feature activation (PGMs)

Using the VDMP3, it is possible to activate the PGM utility keys or PGM groups that are programmed in the EVO panel.

VDMP3 feature numbers do not necessarily correspond to EVO utility key numbers.

For example:

| VDMP3 Feature | EVO Utility Key | VDMP3 Feature | EVO Utility Key |
|---------------|-----------------|---------------|-----------------|
| Feature 1 ON | Utility Key 1 | Feature 5 ON | Utility Key 9 |
| Feature 1 OFF | Utility Key 2 | Feature 5 OFF | Utility Key 10 |
| Feature 2 ON | Utility Key 3 | Feature 6 ON | Utility Key 11 |
| Feature 2 OFF | Utility Key 4 | Feature 6 OFF | Utility Key 12 |
| Feature 3 ON | Utility Key 5 | Feature 7 ON | Utility Key 13 |

| | | | |
|---------------|---------------|---------------|----------------|
| Feature 3 OFF | Utility Key 6 | Feature 7 OFF | Utility Key 14 |
| Feature 4 ON | Utility Key 7 | Feature 8 ON | Utility Key 15 |
| Feature 4 OFF | Utility Key 8 | Feature 8 OFF | Utility Key 16 |



If the utility key in the EVO panel is programmed with a timer, the VDMP3 will not recognize PGM deactivation when the set timer elapses. As a result, the VDMP3 may indicate that the PGM is ON when actually the timer has elapsed and the PGM is in fact OFF

12.3 VDMP3 Setup Instructions

| Step | EVO section | English |
|---------------------------------|------------------|---|
| 1 Enable Functions | [3090] | Select the following options to enable voice reporting and arm/disarm function. [1] Arm/disarm (default 1 and 2 ON) [2] Voice reporting |
| 2 Telephone Numbers | [3091] to [3098] | Program up to 8 telephone numbers which will be called in sequence in the event of an alarm. Telephone numbers should be programmed in priority sequence as the VDMP3 will start with telephone number 1. For extra key functions, see <i>Special Telephone Number Keys</i> on page 72. [3091] Telephone number 1 [3095] Telephone number 5 [3092] Telephone number 2 [3096] Telephone number 6 [3093] Telephone number 3 [3097] Telephone number 7 [3094] Telephone number 4 [3098] Telephone number 8 |
| 3 Enable Numbers | [3133] to [3833] | Choose which telephone numbers will be enabled for each partition in your system. Options [1] to [8] represent telephone numbers 1 through 8. (Default: Telephone number 1 is enabled for all partitions.) [3133] Partition 1 [1] to [8] [3533] Partition 5 [1] to [8] [3233] Partition 2 [1] to [8] [3633] Partition 6 [1] to [8] [3333] Partition 3 [1] to [8] [3733] Partition 7 [1] to [8] [3433] Partition 4 [1] to [8] [3833] Partition 8 [1] to [8] |
| 4 Answering Machine Override | [3052] | If the VDMP3 uses a telephone line that is connected to an answering machine or service, the Answering Machine Override must be programmed. The value programmed in section [3052] represents the delay period that the VDMP3 will wait between the first and second call. The user must call the VDMP3, hang up, and then call back within the value programmed in section [3052]. The module then overrides the answering machine or service by picking up the line on the first ring. 000 to 225 seconds (default 008) Note: Changing these values will also affect PC communication via WinLoad software. |
| 5 Enable Features (PGM) | [3087] | Features in this section correspond to utility key PGMs in the EVO control panel. For more information, see Feature Activation (PGMs). Options [1] to [8] represent features 1 to 8 (default: OFF) |
| 6 Message Delay | [3088] | After the VDMP3 dials a phone number, it waits the programmed delay period before sending the voice message. The value programmed in section [3088] represents the length of time the VDMP3 will wait before playing the message. 000 to 127 seconds (default 003) |
| 7 Message Repetitions | [3089] | Set the number of times the VDMP3 will play the voice message. 000 to 008 repetitions (default 008) |
| 8 Delay Before Next Number | [3054] | Set the delay before the VDMP3 attempts to dial the next number on the list. 000 to 255 seconds (default 020) Note: Changing these values will also affect regular reporting to monitoring station. |

| | |
|-----------------------------|---|
| 9 Ring Counter | Set the number of rings the VDMP3 will wait before the call is answered. 000 to 008 rings (default 008) Note: Changing these values will also affect PC communication via WinLoad software. |
|-----------------------------|---|

The control panel provides a maximum of 100 mA to PGM1 to PGM4. PGM5 is a 5A/28Vdc N.O./ N.C. relay output. Activating a PGM changes its state from open to closed or closed to open. Refer to see *section 2.15* on page 18.

13.1 PGM Activation Event

The PGM Activation Event determines which event will activate the PGM. The Event Group specifies the event, the Feature Group identifies the source, and the Start # and End # sets the range within the Feature Group (see *PGM Programming Table* in the "EVO Programming Guide").

Enter the sections that correspond to the Event Group, Feature Group, Start # and End # of the desired PGM and enter the desired 3-digit number from the PGM Programming Table:

| | Event Group | Feature Group | Start # | End # |
|--------|-------------|---------------|---------|--------|
| PGM 1: | [0910] | [0911] | [0912] | [0913] |
| PGM 2: | [0920] | [0921] | [0922] | [0923] |
| PGM 3: | [0930] | [0931] | [0932] | [0933] |
| PGM 4: | [0940] | [0941] | [0942] | [0943] |
| PGM 5: | [0950] | [0951] | [0952] | [0953] |

13.2 PGM Deactivation Option

Once the PGMs are activated, they can deactivate when another event occurs or after a period of time. Enter the section that corresponds to the desired PGM and enable or disable option [1] (default = **PGM Deactivation Event**):

| PGM 1: [0919] | <table border="1"> <thead> <tr> <th>Option</th> <th></th> <th>Feature</th> </tr> </thead> <tbody> <tr> <td>[1]</td> <td>ON</td> <td>PGM Timer</td> </tr> <tr> <td>[1]</td> <td>OFF</td> <td>PGM Deactivation Event</td> </tr> <tr> <td>[4]</td> <td>ON</td> <td>Normally Closed</td> </tr> <tr> <td>[4]</td> <td>OFF</td> <td>Normally Open</td> </tr> </tbody> </table> | Option | | Feature | [1] | ON | PGM Timer | [1] | OFF | PGM Deactivation Event | [4] | ON | Normally Closed | [4] | OFF | Normally Open |
|---------------|--|---------------|------------------------|---------|-----|----|-----------|-----|-----|------------------------|-----|----|-----------------|-----|-----|---------------|
| Option | | | Feature | | | | | | | | | | | | | |
| [1] | | ON | PGM Timer | | | | | | | | | | | | | |
| [1] | | OFF | PGM Deactivation Event | | | | | | | | | | | | | |
| [4] | | ON | Normally Closed | | | | | | | | | | | | | |
| [4] | OFF | Normally Open | | | | | | | | | | | | | | |
| PGM 2: [0929] | | | | | | | | | | | | | | | | |
| PGM 3: [0939] | | | | | | | | | | | | | | | | |
| PGM 4: [0949] | | | | | | | | | | | | | | | | |
| PGM 5: [0959] | | | | | | | | | | | | | | | | |

13.3 Flexible PGM Deactivation Option

The PGM Deactivation Option must be set to *PGM Timer* for this feature to function. The Flexible PGM Deactivation Option uses both the PGM Deactivation Event and the PGM Timer. When enabled, and if the PGM is activated, it will deactivate when **either** the PGM Deactivation Event occurs **or** the PGM Timer elapses, whichever happens first.

Enter the section corresponding to the PGM and enable option [3] (default = **disabled**):

| | | |
|---------------|---------------|---------------|
| PGM 1: [0919] | PGM 2: [0929] | PGM 3: [0939] |
| PGM 4: [0949] | PGM 5: [0959] | |

13.4 PGM Deactivation Event

The PGM Deactivation Event determines which event will return the PGM to its original state. The Event Group specifies the event, the Feature Group identifies the source, and the Start # and End # determine the range within the Feature Group.

Enter the sections that correspond to the Event Group, Feature Group, Start # and End # of the desired PGM and enter the desired 3-digit number from the PGM Programming Table.

| | Event Group | Feature Group | Start # | End # |
|--------|-------------|---------------|---------|--------|
| PGM 1: | [0914] | [0915] | [0916] | [0917] |
| PGM 2: | [0924] | [0925] | [0926] | [0927] |
| PGM 3: | [0934] | [0935] | [0936] | [0937] |
| PGM 4: | [0944] | [0945] | [0946] | [0947] |
| PGM 5: | [0954] | [0955] | [0956] | [0957] |

13.5 PGM Timer

When the PGM Deactivation Option is enabled, the PGM Timer determines how many seconds or minutes the PGM remains activated.

Enter the section that corresponds to the desired PGM and enter a value from 001 to 255 (default = **005**). The value entered is either in seconds or minutes as determined by the PGM Time Base Selection:

| | | |
|---------------|---------------|---------------|
| PGM 1: [0918] | PGM 2: [0928] | PGM 3: [0938] |
| PGM 4: [0948] | PGM 5: [0958] | |

13.5.1 PGM Time Base Selection

The PGM Time Base Selection determines whether the PGM Timers are in minutes or seconds (default = **seconds**):

| PGM 1: [0919] | <table border="1"> <thead> <tr> <th>Option</th> <th></th> <th>Feature</th> </tr> </thead> <tbody> <tr> <td>[2]</td> <td>ON</td> <td>Minutes</td> </tr> <tr> <td>[2]</td> <td>OFF</td> <td>Seconds</td> </tr> </tbody> </table> | Option | | Feature | [2] | ON | Minutes | [2] | OFF | Seconds |
|---------------|--|--------|---------|---------|-----|----|---------|-----|-----|---------|
| Option | | | Feature | | | | | | | |
| [2] | | ON | Minutes | | | | | | | |
| [2] | | OFF | Seconds | | | | | | | |
| PGM 2: [0929] | | | | | | | | | | |
| PGM 3: [0939] | | | | | | | | | | |
| PGM 4: [0949] | | | | | | | | | | |
| PGM 5: [0959] | | | | | | | | | | |

13.6 PGM1 Becomes a 2-wire Smoke Detector Input*

SECTION [3030]: OPTION [1]

(default = **disabled**) When enabled, PGM1 acts as a zone input for two-wire smoke detectors. When programming Zone Numbering the control panel will recognize PGM1 as input number 255.

* **UL Note:** Not verified by UL.

13.7 PGM Test Mode

Entering sections [0901] to [0903] activates the corresponding PGM for 8 seconds to verify if the PGM is functioning as desired.

| | | |
|---------------|---------------|---------------|
| PGM 1: [0901] | PGM 2: [0902] | PGM 3: [0903] |
| PGM 4: [0904] | PGM 5: [0905] | |

13.8 PGM Initial Status

Use this option to set the initial state for the PGM.

| |
|----------------------|
| PGM 1: [0919] |
| PGM 2: [0929] |
| PGM 3: [0939] |
| PGM 4: [0949] |
| PGM 5: [0959] |

| Option | | Feature |
|---------------|------------|-----------------|
| [4] | ON | Normally Closed |
| [4] | OFF | Normally Open |

14.1 Hardware Reset

A Hardware Reset sets sections [0001] to [3991] to default. Only the Panel ID, PC Password, PC Telephone Number and Event Buffer are not reset. The Installer Code Lock prevents Hardware Reset.

1. Make sure the Installer Code Lock is disabled
2. Press and hold the Reset and Aux buttons for 3 seconds
3. The panel will be reset to defaults

14.2 Software Reset

Performing a software reset will set certain parameters to default values or program certain sections with a set of pre-defined values. To reset:

1. Enter *Panel Programming Mode* (see section 3.4).
2. Enter section [4049] to unlock software reset.
3. Enter the 4-digit [SECTION] of the software reset you wish to perform.
4. For every other section your want to reset, you will have to unlock software reset.

| | |
|--------|--|
| [4040] | Resets the programmable sections from [0001] to [3991] to default (even if Installer Code Lock is enabled) except: Event Buffer, Panel ID, PC Password, PC Telephone Number and Zone, Door, Partition and User Labels (see section 15.4 on page 97). |
| [4041] | Resets the System Master Code to 123456. |
| [4042] | Resets all Zone Programming sections from [0001] to [0196], [0201] to [0296] and [0961] to [0984] to default. |
| [4043] | Resets the Access Control sections, except Door Labels, from [2201] to [2712] to default. |
| [4044] | Resets all User Access Code Programming sections from [1001] to [1999] and [2001] to [2199] to default. User Labels (see section 15.4 on page 97) will not be reset. |
| [4045] | Resets all control panel settings from [3020] to [3043] and from [3900] to [3991] and all the Dialer sections from [3051] to [3081]. |
| [4046] | Resets all Partition Settings, except Partition Labels, from [3101] to [3831] to default. |
| [4047] | Resets Keyswitch Programming sections from [0501] to [0832] and all Programmable Outputs sections from [0901] to [0939] to default. |

| | |
|--------|---|
| [4048] | Entering this section resets the User Labels from the User Access Codes, the Zone Labels from [0301] to [0396], Door Labels from [2301] to [2332], Partition Labels [3100], [3200], [3300], [3400], [3500], [3600], [3700] and [3800] to default. |
| [4049] | Entering this section will unlock software reset for sections [4040] to [4048]. |

 **Do not remove power from the control panel.**

14.3 Installer Code Lock

SECTION [3001]

(default = **000**) Enter 147 into section [3001] to lock all programming. When 147 is programmed, performing a hardware reset as described in *section 14.1* will not affect the current panel settings. To remove the Installer Lock, enter 000 into section [3001].

14.4 Daylight Savings Time

SECTION [3030]: OPTION [3]

(default = **enabled**) When enabled, the control panel adjusts the system's clock (time) for daylight saving changes.

14.5 Daylight Savings Time Schedule

SECTION [3022]

(default = **18**)

Select the schedule followed for the Daylight Savings Time adjustment.

| | | | |
|-----------|--|-----------|-------------------------------------|
| 00 | Canada/United States/Mexico/ St-Johns/Bahamas/Turks and Caicos | 01 | Cuba |
| 02 | Brazil | 03 | Chile |
| 04 | Falkland Islands | 05 | Paraguay |
| 06 | European Union/United Kingdom/Greenland | 07 | Russia and surrounding countries |
| 08 | South Australia/Victoria/ Australian Capital Territory/New South Wales | 09 | Tasmania/Lord Howe Island |
| 10 | New-Zealand/Chatham | 11 | Tonga |
| 12 | Iraq/Syria | 13 | Israel (TBC) |
| 14 | Lebanon/Kirgizstan | 15 | Palestine |
| 16 | Egypt | 17 | Namibia |
| 18 | Canada/United States 2007 (default) | 19 | New Zealand |

14.6 Battery Charge Current

SECTION [3030]: OPTION [5]

Depending on the battery's capacity, enable or disable the option:

| | | |
|-----|-----|-----------------|
| [5] | ON | 850mA |
| [5] | OFF | 350mA (default) |



A 40VA transformer is required when selecting the 850mA battery charge current, a 20VA transformer may damage the system.

14.7 Combus Speed

SECTION [3030]: OPTION [8]

In large installations, set the speed to High. If you are experiencing communication troubles, set the speed to Normal or install a Hub (APR3-HUB2). The control panel will restart when a change is made

| | | |
|-----|-----|------------------------|
| [8] | ON | High Speed |
| [8] | OFF | Normal Speed (default) |



Please note that when the combus speed is changed the following will occur and is considered normal operation:

- The message COMM. TROUBLE CALL SERVICE will be displayed on keypads connected to the combus.
- The AC and STATUS LEDs will begin to alternately flash and all operations on the system will be suspended for approximately one minute while the system reconfigures.

14.8 Transmit Zone Status on Serial Port

SECTION [3035]: OPTION [7]

When enabled, the control panel will transmit zone status information through the serial port. Use this when there are devices or software connected to the serial port like WinLoad.

14.9 Serial Port Baud Rate

SECTION [3035]: OPTION [8]

Adjust depending on the baud rate set in WinLoad or NEware:

| | | |
|-----|-----|-----------------------|
| [8] | ON | 57,600 baud |
| [8] | OFF | 38,400 baud (default) |



If communication between the control panel and the computer is experiencing difficulty at 57,600 baud, especially over long distances reduce the baud rate of the software to 38,400 baud.

14.10 Partitioning

SECTION [3031]: OPTIONS [1] TO [8]

(default = **partition 1 enabled**) The control panel can provide up to eight completely independent partitions. Most features and options can be independently set for each partition. All zones, keyswitch zones, user codes and system modules are assigned to specific partitions. The EVO48 only has 4 partitions.

| | | | | | | | |
|-----|-------------|-----|-------------|-----|-------------|-----|-------------|
| [1] | Partition 1 | [3] | Partition 3 | [5] | Partition 5 | [7] | Partition 7 |
| [2] | Partition 2 | [4] | Partition 4 | [6] | Partition 6 | [8] | Partition 8 |

14.10.1 Panel Partition Assignment

SECTION [3020]

(default = **00**) The control panel will report system events as originating from one or all enabled partitions. The System Troubles can only be viewed through the partitions enabled in this section. Enter a 2-digit decimal number from 01 to 08 which represent partitions 1 to 8. Enter 00 to disable this feature.

14.11 Shabbat Feature

SECTION [3030]: OPTION [4]

(default = **disabled**) When enabled, addressable detectors and keypads in the system no longer display system status through the LCD and/or LEDs between noon Friday and midnight Saturday. Normal operation is re-instated Sunday at 12:00:01a.m. A user can access all the usual commands and features during the Shabbat period by pressing a key or by entering their access code (depending on how Confidential Mode is configured in the keypad). When no actions have occurred for two minutes, the Shabbat feature will re-activate. During the Shabbat period:

- the LCD keypads only display the date and time
- the backlight is disabled
- the LED indicators on modules are disabled

14.12 Installer Function Keys

Press and hold the [0] key and key in the [INSTALLER CODE] to access the installer functions and then:

For LCD keypads: Press the key indicated in the list below that corresponds to the function you wish to activate.

For Grafica keypads: Press the center action key (**Options**), highlight the desired function and then press the center action key (**Ok**).

| | |
|----------|---|
| [STAY] | TEST REPORT: Sends the <i>Test Report</i> report code programmed in section [3902] to the monitoring station. |
| [FORCE] | CALL WINLOAD: Dials the PC telephone number programmed in section [3010] to communicate using WinLoad. |
| [ARM] | ANSWER WINLOAD: Forces the control panel to answer a call made by the monitoring station that is using WinLoad. |
| [DISARM] | CANCEL COMMUNICATION: Cancels all communication with the monitoring station or WinLoad until the next reportable event. |
| [MEM] | INSTALLER TEST MODE: Perform walk tests where the bell or siren squawks once when a zone opens and twice when it closes. Press [MEM] again to exit. Partitions cannot be armed if the Installer Test Mode is enabled. |
| [TRBL] | START MODULE SCAN: Verifies the status of modules on the combus. The LCD Keypads display the serial number of each module connected to the combus. |
| [ACC] | START VOLTMETER READING (K641 only): Verifies if the combus is supplying enough power at the keypad's location. |

14.13 Module Reset

SECTION [4001]

To reset a module connected to the combus to its default values, key in the module's serial number into section [4001].

14.14 Locate Module

SECTION [4002]

To locate a specific module on the combus, key in the module's serial number into section [4002]. The LED on the module flashes until the serial number is entered or the module's tamper or unlocate switch is pressed.

14.15 Module Programming

SECTION [4003]

To program a module, enter section [4003] to enter *Module Programming Mode* (see section 3.5 on page 30), and enter the module's serial number. To exit, press the [CLEAR] key until Normal Mode is displayed.

14.16 Module and Label Broadcast

SECTION [4004]

Module Broadcast

To copy the contents of the programming sections from one module to another, enter the serial number of the source module in section [4004], enter the serial numbers of all the destination modules and press [ACC] or the center action key (**Start**).

Label Broadcast

Copy the User Labels, Zone Labels (sections [0301] to [0396]), the Door Labels (sections [2301] to [2332]) and the Partition Labels (sections [3100], [3200], [3300], [3400], [3500], [3600], [3700] and [3800]) to all the modules in the system that support these labels. To transmit the labels, in section [4004], enter the control panel's serial number. From the Destination screen, do not enter a serial number and press [ACC] if using an LCD keypad or the center action key (**Start**) if using a Grafica keypad.



The Module and Label Broadcast feature will only work when a module is broadcasting its data to a module or to modules of the same type and model number.

14.17 System Date & Time

The System Date and Time is programmed through the User Menu.

14.18 Quick Module Scanning

SECTION [4005]

After entering the section, the control panel will scan all addresses assigned to modules. If any missing modules are detected (i.e. detector

removed from the combus), the control panel will erase the module's serial number, removing the module from the control panel's memory.

14.19 Module Scanning

SECTION [4006]

After entering the section, the control panel will scan all addresses on the combus. If any missing modules are detected (i.e. detector

removed from the combus), the control panel will erase the module's serial number, removing the module from the control panel's memory.

If new modules are detected, the serial number will be entered in the control panel's memory.

14.20 Serial Number Viewing

SECTION [4000]

Enter section **[4000]** to view the serial number of the control panel and all the modules on the combus. The firmware version of some modules will be displayed as well (e.g. (XXXXXXXX) VXX.XX).

For LCD Keypads: The keypad will display the control panel's serial number. Use the [**▲**] and [**▼**] keys to scroll.

For Grafica Keypads: The keypad will display the control panel's serial number. Press the center action key (**Next**) to scroll.

14.21 Power Save Mode

SECTION [3033]: OPTIONS [4]

(default = **enabled**) When enabled and the control panel is running on the backup battery, the control panel can set all keypads into Power Save Mode. The keypad's backlight and LEDs are disabled until a key is pressed, an alarm occurs or an Entry Delay is triggered.

14.22 Auto Trouble Shutdown

SECTION [3021]

(default = **00**) If a trouble occurs more than the number programmed, the control panel stops reporting the trouble. Enter a value between 01 and 15, (00 = disabled). Each trouble has its own counter that is reset at midnight.

14.23 No AC Fail Display

SECTION [3030]: OPTION [6]

(default = **disabled**) When enabled, the control panel will not display the AC Failure as a trouble. When an AC Failure occurs with this option enabled:

- the AC LED will extinguish
- the AC Failure report code will be reported.
- the trouble will not appear in the Trouble Display
- the keypad will not beep to indicate the trouble

14.24 Multiple Action Feature

SECTION [3033]: OPTION [1]

(default = **disabled**) When enabled, users will remain in the User Menu after entering their access code. With option [1] off, the control panel will exit the User Menu after every action.

14.25 System Labels

The existing label displayed on the LCD screen can be modified to suit the installation's needs. Each label contains a maximum of 16 characters.

To re-program the System Label, enter the desired section and use *Table 7*, *Table 9* and *Table 8* (page 93) to modify the label. For other languages, refer to *Table 10* to *Table 14* on page 96. For instructions on how to enter letters and special characters for the Grafica keypad, refer to "Grafica's Online Manual". A complete "Grafica Online Manual" is available on our website at paradox.com.

| |
|---|
| Zone Labels: Sections [0301] to [0396] represent Zones 01 to 96. |
| Door Labels: Sections [2301] to [2332] represent Doors 01 to 32. |

| Partition Labels: | | | |
|---------------------|---------------------|---------------------|---------------------|
| Partition 1: [3100] | Partition 3: [3300] | Partition 5: [3500] | Partition 7: [3700] |
| Partition 2: [3200] | Partition 4: [3400] | Partition 6: [3600] | Partition 8: [3800] |

Table 7: Keys

| Press | Feature | Description |
|----------|-------------------------|--|
| [STAY] | Insert Space | Inserts a blank space in the cursor's position |
| [FORCE] | Delete | Deletes the character or blank space found at the cursor's position |
| [ARM] | Delete Until the End | Deletes all characters and spaces to the right of the cursor and at the cursor's position |
| [DISARM] | Numeric or Alphanumeric | Switches from numeric keys to alphanumeric keys and vice versa (see Table 8) |
| [BYP] | Lower or Upper Case | Switches the case setting from lower to upper case and vice versa |
| [MEM] | Special Characters | The cursor will turn into a flashing black square. Enter the 3-digit number that represents the desired symbol (see <i>Table 9</i> on page 94, <i>Table 13</i> on page 95 and <i>Table 14</i> on page 96). |

Table 8: Numeric and Alphanumeric keys

| Key | Numeric | Alphanumeric | | |
|-----|--------------------|--------------------|---------------------|-----------------------|
| | Press key one time | Press key one time | Press key two times | Press key three times |
| [0] | 0 | --- | --- | --- |
| [1] | 1 | A | B | C |
| [2] | 2 | D | E | F |
| [3] | 3 | G | H | I |
| [4] | 4 | J | K | L |
| [5] | 5 | M | N | O |
| [6] | 6 | P | Q | R |
| [7] | 7 | S | T | U |
| [8] | 8 | V | W | X |
| [9] | 9 | Y | Z | |

Table 9: Special Characters Catalogue

| | | | | | | | | | | | | | |
|-----|-----|-----|-----|-----|-----|-----|-----|-----|-----|-----|-----|-----|-----|
| 032 | 048 | 064 | 080 | 096 | 112 | 128 | 144 | 160 | 176 | 192 | 208 | 224 | 240 |
| ! | 1 | A | Q | a | q | ù | é | î | + | · | α | ρ | |
| !" | 2 | B | R | b | r | ú | ê | ï | + | · | β | σ | |
| # | 3 | C | S | c | s | û | ë | í | ↑ | β | · | ¼ | ∞ |
| \$ | 4 | D | T | d | t | ü | è | ï | ↓ | ç | · | ½ | Ω |
| % | 5 | E | U | e | u | ÿ | é | í | ← | ⊗ | · | ¾ | ∫ |
| & | 6 | F | V | f | v | ÿ | é | í | ← | ⊗ | · | ¾ | ∫ |
| ' | 7 | G | W | g | w | ö | e | ñ | £ | ⋈ | « | 9 | ~ |
| < | 8 | H | X | h | x | ò | á | ñ | → | ∫ | » | ↑ | φ |
|) | 9 | I | Y | i | y | ó | ä | ñ | ↓ | ∅ | · | ↓ | ∫ |
| * | 0 | J | Z | j | z | ô | á | ñ | ↑ | ∫ | · | ↓ | ∫ |
| + | ; | K | L | k | l | õ | ä | ñ | ↓ | ∅ | · | ∫ | ∫ |
| , | < | L | / | l | l | ö | ä | ñ | ↓ | ∅ | · | ∫ | ∫ |
| - | = | M | J | m | j | ó | á | ñ | ↑ | ∫ | · | ∫ | ∫ |
| . | > | N | > | n | → | ô | á | ñ | ↑ | ∫ | · | ∫ | ∫ |
| / | ? | O | - | o | ← | ó | á | ñ | ↑ | ∫ | · | ∫ | ∫ |

Table 10: Hebrew Keypad Letter Assignment

| Key | Press key once | Press key twice | Press key three times |
|-----|----------------|-----------------|-----------------------|
| [1] | א | ב | ג |
| [2] | ד | ה | ו |
| [3] | ז | ח | ט |
| [4] | י | כ | ל |
| [5] | מ | נ | ס |
| [6] | ע | פ | צ |
| [7] | ק | ר | ש |
| [8] | ת | ך | ץ |
| [9] | ך | ץ | ץ |

Table 11: Russian Keypad Letter Assignment

| Key | Press key once | Press key twice | Press key three times | Press key four times |
|-----|----------------|-----------------|-----------------------|----------------------|
| [1] | А | Б | В | Г |
| [2] | Д | Е | Ё | Ж |
| [3] | З | И | Й | К |
| [4] | Л | М | Н | О |
| [5] | П | Р | С | Т |
| [6] | У | Ф | Х | Ц |
| [7] | Ч | Ш | Щ | Ъ |
| [8] | Ы | Ь | Э | Ю |
| [9] | Я | | | |

Table 12: Greek Keypad Assignment

| Key | Press key once | Press key twice | Press key three times |
|-----|----------------|-----------------|-----------------------|
| [1] | A | B | G |
| [2] | D | E | Z |
| [3] | H | Q | I |
| [4] | K | L | M |
| [5] | N | Ξ | O |
| [6] | P | R | S |

Table 12: Greek Keypad Assignment

| | | | |
|-----|---|---|---|
| [7] | T | U | F |
| [8] | C | Y | W |

Table 13: Hebrew Special Characters Catalogue

| | | | | | | | | | | | |
|-----|-----|-----|-----|-----|-----|-----|-----|-----|-----|-----|-----|
| 032 | 048 | 064 | 080 | 096 | 112 | 160 | 176 | 192 | 208 | 224 | 240 |
| ! | 1 | A | Q | a | q | ו | ו | ז | ז | ח | ח |
| " | 2 | B | R | b | r | י | י | כ | כ | ל | ל |
| # | 3 | C | S | c | s | ט | ט | ך | ך | ש | ש |
| φ | 4 | D | T | d | t | ק | ק | ל | ל | מ | מ |
| % | 5 | E | U | e | u | י | י | נ | נ | ס | ס |
| & | 6 | F | V | f | v | ז | ז | ע | ע | פ | פ |
| ' | 7 | G | W | g | w | פ | פ | צ | צ | ק | ק |
| < | 8 | H | X | h | x | ק | ק | ר | ר | ש | ש |
|) | 9 | I | Y | i | y | י | י | ת | ת | י | י |
| * | : | J | Z | j | z | י | י | י | י | י | י |
| + | Γ | K | W | k | w | י | י | י | י | י | י |
| ' | < | L | Π | l | π | י | י | י | י | י | י |
| - | = | M | X | m | x | י | י | י | י | י | י |
| ◦ | > | N | ^ | n | ^ | י | י | י | י | י | י |
| / | ד | O | φ | o | φ | י | י | י | י | י | י |

Table 14: Russian Special Characters Catalogue

| | | | | | | | | | | | | | |
|-----|---|---|---|---|----|--|--|---|---|----|----|----|---|
| 032 | 0 | 0 | P | ` | p | | | Б | Ю | Ч | | Д | ¼ |
| 033 | 1 | A | Q | a | q | | | Г | Я | Ш | | Ц | ⅓ |
| 034 | 2 | B | R | b | r | | | Ё | О | Ъ | | Щ | ½ |
| 035 | 3 | C | S | c | s | | | Ж | В | Ы | !! | Л | |
| 036 | 4 | D | T | d | t | | | З | П | Ь | | Ф | |
| 037 | 5 | E | U | e | u | | | И | Ё | Э | | И | |
| 038 | 6 | F | V | f | v | | | Й | Ж | Ю | | Ш | |
| 039 | 7 | G | W | g | w | | | Л | З | Я | | ' | |
| 040 | 8 | H | X | h | x | | | П | И | « | | •• | |
| 041 | 9 | I | Y | i | y | | | У | Й | » | ↑ | ~ | |
| 042 | : | J | Z | j | z | | | Ф | К | // | ↓ | é | |
| 043 | ; | K | [| k | 10 | | | Ч | Л | " | | Ç | |
| 044 | < | L | ç | l | 12 | | | Ш | М | | | ij | |
| 045 | = | M |] | m | 15 | | | Ь | И | ¿ | | ☀ | § |
| 046 | > | N | ^ | n | ← | | | Ы | П | f | | | ¶ |
| 047 | ? | O | _ | o | | | | Э | Т | £ | | ◦ | |

Table 15: Greek Special Characters Catalogue

| | | | | | | | | | | | | | | | |
|-----|---|----|---|---|---|---|---|---|---|---|---|---|---|---|---|
| 016 | ± | 0 | 0 | P | ` | p | ς | έ | ά | · | Γ | Μ | β | τ | |
| 017 | ≡ | 1 | A | Q | α | α | ü | æ | ί | · | J | + | Υ | υ | |
| 018 | ∇ | 2 | B | R | b | γ | έ | ε | ό | ο | ω | ς | δ | χ | |
| 019 | ∫ | # | 3 | C | S | c | s | α | ο | ύ | ∇ | ¶ | ε | ψ | |
| 020 | ∫ | \$ | 4 | D | T | d | t | ä | ö | φ | ∇ | ζ | ω | | |
| 021 | ∫ | % | 5 | E | U | e | u | ä | ö | ε | ½ | ↑ | ∇ | η | ¶ |
| 022 | ∫ | & | 6 | F | V | f | v | ü | ü | φ | ¼ | ↓ | θ | θ | ¶ |
| 023 | ∫ | ' | 7 | G | W | g | w | ς | ύ | β | x | → | ∇ | λ | ¶ |
| 024 | ∫ | < | 8 | H | X | h | x | ε | ü | ς | ÷ | ← | ε | κ | ¶ |
| 025 | ∫ |) | 9 | I | Y | i | y | é | ö | ι | ∫ | ∇ | π | λ | ¶ |
| 026 | ≈ | * | = | J | Z | j | z | è | ü | ∫ | > | ∇ | σ | μ | F |
| 027 | ∫ | + | = | K | [| k | ∫ | ∫ | ∫ | ∫ | ∫ | ∫ | ∫ | ∫ | ∫ |
| 028 | = | ' | < | L | ∫ | ∫ | ∫ | ∫ | ∫ | ∫ | ∫ | ∫ | ∫ | ∫ | ∫ |
| 029 | ∫ | - | = | M | ∫ | ∫ | ∫ | ∫ | ∫ | ∫ | ∫ | ∫ | ∫ | ∫ | ∫ |
| 030 | ∫ | > | N | ∫ | ∫ | ∫ | ∫ | ∫ | ∫ | ∫ | ∫ | ∫ | ∫ | ∫ | ∫ |
| 031 | ∫ | ∫ | ∫ | ∫ | ∫ | ∫ | ∫ | ∫ | ∫ | ∫ | ∫ | ∫ | ∫ | ∫ | ∫ |

15.1 Installer Code

SECTION [1000]

(default = **000000**) The Installer Code is six digits in length where each digit can be any value from 0 to 9. To change the Installer Code:

1. Press and hold [0]
2. Enter [INSTALLER CODE]
3. Key in [1000]
4. Enter new 6-digit [INSTALLER CODE]



The Installer Code can program the User Code Options and the Partition Assignment, but cannot program the personal identification numbers.

15.2 Access Code Length

SECTION [3033]: OPTIONS [2] AND [3]

Access codes can be 1 to 6 digits in length if flexible user access code is enabled. When programming access codes with less than 6 digits, press the [ENTER] key after entering the last digit. The control panel automatically removes the last 2 digits of the user access code if the length is changed from 6 digits to 4 digits. However, if the user access code length is changed from 4 digits to 6 digits, the control panel adds 2 digits to the end by using the first 2 digits.

| [2] | [3] | |
|-----|-----|------------------------------------|
| OFF | OFF | 4-digit User Access Code (default) |
| OFF | ON | 6-digit User Access Code |
| ON | ON | Flexible User Access Code |

15.3 System Master Code

SECTION [1001]

(default = **123456**) The Installer Code can change the User Code Options, Partition Assignment and Access Control Options, but cannot change the personal identification number (PIN). Each digit in the System Master Code can be any value from 0 to 9. To reset the System Master Code, refer to see *section 14.2* on page 87. With the System Master Code, a user can use any of the available arming methods with access to all partitions and can program all user access codes, User Options, Partition Assignments and Access Control Options.

15.4 Programming Access Codes

SECTIONS [1002] TO [1999]

(default = **all options are off except bypass**) The control panel supports 998 user access codes. In sections [1002] to [1999], the Installer Code can program the User Code Options, Partition Assignment and Access Control Options, but cannot program the personal identification numbers (PIN). To program the PINs, refer the users to the "System Manager's Manual". The System Master Code or a user with the Master feature enabled can program the User Code Options, Partition Assignment, Access Control Options and User Labels using a different method of programming.



If no partition assignment is selected, the user access code will **only** be able to activate PGMs.

To program user labels, refer to the “LCD Keypad System Manager’s Manual” or to the “Grafica Graphic LCD Keypad Online Help”.

15.5 User Options

SECTIONS [1002] TO [1999]: USER OPTIONS SCREEN, OPTIONS [1] TO [8]

The User Options define how each user access code can arm or disarm the partitions. All users can Regular arm their assigned partitions, but only those with the Arm Only option disabled can disarm an assigned partition.

Enable or disable the options as required for each user access code as shown in *Figure 21*.

Figure 21: Programming User Access Codes

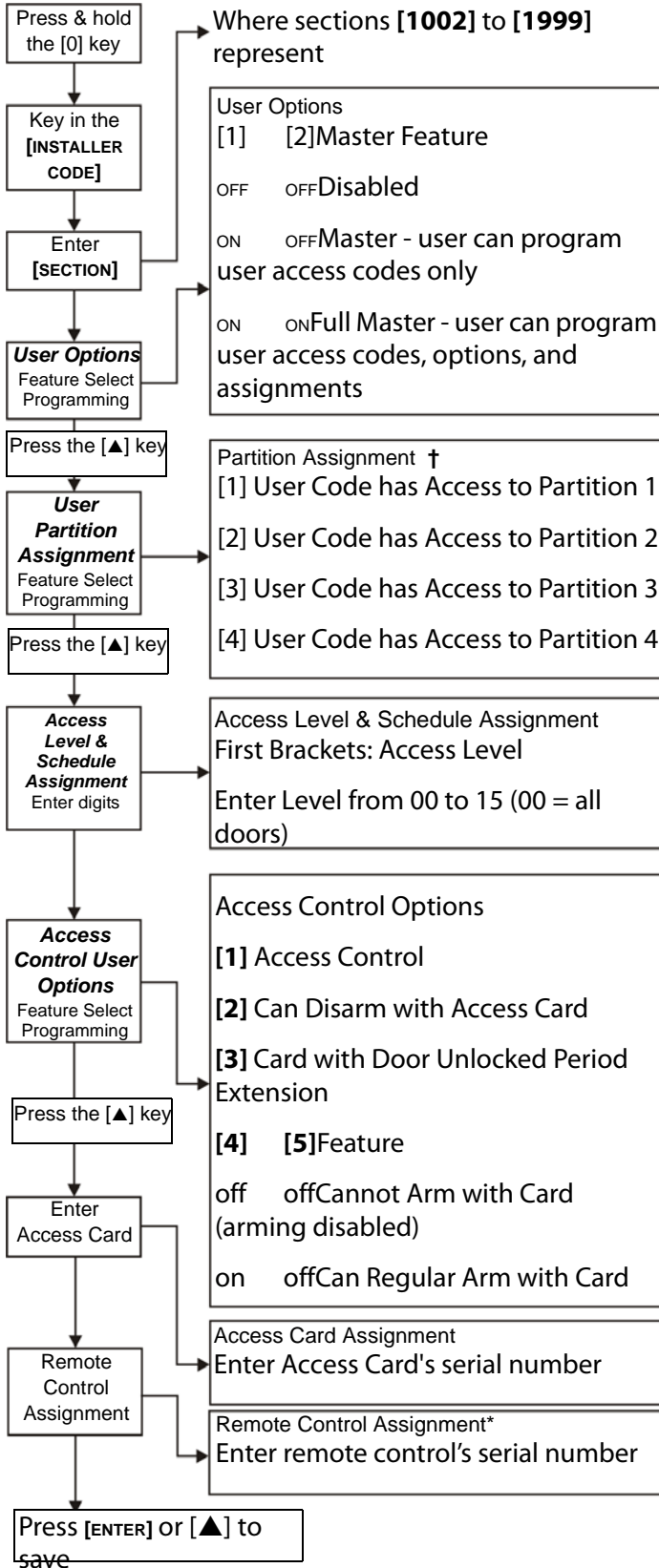

† The default setting depends on the programming user's assigned partitions. For example, when a user (with master feature) that is assigned to partitions 1 and 2 programs a user code, partitions 1 and 2 will be the default setting for the new user.

* Remote controls can also be assigned using a Master Code.

15.6 Partition Assignment

SECTIONS [1002] TO [1999]: ASSIGN AREA SCREEN, OPTIONS [1] TO [8]

Each of the 998 user access codes can be assigned to one or more partitions. Users can only arm, disarm and view the status of the partitions assigned to their user access codes. Select one or more of the partitions for each user access code as shown in *Figure 21* on page 99.



If no partition assignment is selected, the user access code will **only** be able to activate PGMs.

The default setting depends on the programming user's assigned partitions. For example, when a user (with master feature) that is assigned to partitions 1 and 2 programs a user code, partitions 1 and 2 will be the default setting for the new user.

| [1] | [2] | | |
|-----|-----|---------------------|--|
| OFF | OFF | Master disabled | User cannot create or modify other user access codes. |
| ON | OFF | Master enabled | User can create new user access codes with default options only, can program PINs and User Labels. |
| ON | ON | Full Master enabled | User can create and modify user access codes and program the User Options, Partition Assignment (can assign only the partitions the Master Code has access to), Access Control features, PINs and User Labels. |
| [3] | | Duress | A Duress enabled user access code can arm or disarm the partition and can immediately transmit a silent alarm to the monitoring station. |
| [4] | | Bypass | User can program bypass entries. |
| [5] | | Arm Only | User can arm assigned partitions, but cannot disarm. |
| [6] | | Stay or Instant Arm | User can Stay arm or Instant arm assigned partitions. |
| [7] | | Force Arm | User can Force arm assigned partitions |
| [8] | | User Menu Access | Option [8] ON = User can access all its assigned partitions, regardless of the keypad's partition assignment. Option [8] OFF = User can only access the partitions assigned to both itself and the keypad. |

Appendix A: Automatic Report Code List

| System Event | Default Contact ID Report Code when using sections [4032] to [4037] | Default SIA Report Code when using sections [4032] to [4037] |
|--|---|--|
| Arming with Master Code (##) | 3 4A1 - Close by user | CL - Closing Report |
| Arming with User Code (##) | 3 4A1 - Close by user | CL - Closing Report |
| Arming with Keypad (##) | 3 4A9 - Keypad Close | CS - Closing Keypad |
| Auto Arming | 3 4A3 - Automatic Close | CA - Automatic Closing |
| Arm with PC software | 3 4A7 - Remote arm/disarm | CQ - Remote Arming |
| Late To Close | 3 452 - Late to Close | OT - Late to Close |
| No Movement | 3 452 - Late to Close | NA - No Movement Arming |
| Partial arming | 1 456 - Partial Arm | CG - Close Area |
| Quick arming | 3 4A8 - Quick arm | CL - Closing Report |
| Remote Arm (voice) | 3 4A7 - Remote Arm | CQ - Arm with Voice Module |
| Delinquency Closing | 1 654 - System Inactivity | CD - System Inactivity |
| Disarm with Master Code (##) | 1 4A1 - Open by user | OP - Opening Report |
| Disarm with User Code (##) | 1 4A1 - Open by user | OP - Opening Report |
| Disarm with Keypad (##) | 1 4A9 - Keypad Open | OS - Opening Keypad |
| Disarm after alarm with Master Code (##) | 1 4A1 - Open by user | OP - Opening Report |
| Disarm after alarm with User Code (##) | 1 4A1 - Open by user | OP - Opening Report |
| Disarm after alarm with Keypad (##) | 1 4A9 - Keypad Open | OS - Opening Keypad |
| Cancel alarm with Master Code (##) | 1 4A6 - Cancel | OR - Disarm From Alarm |
| Cancel alarm with User Code (##) | 1 4A6 - Cancel | OR - Disarm From Alarm |
| Cancel alarm with Keypad (##) | 1 4A6 - Cancel | OS - Opening Keypad |
| Auto Arming Cancellation | 1 464 - Auto-Arm Time Extended | CE - Closing Extend |
| Cancel Alarm with PC Software | 1 4A6 - Cancel | OR - Disarm From Alarm |
| Voice Disarm | 1 4A7 - Remote arm/disarm | OQ - Remote Disarming |
| Disarm with PC software | 1 4A7 - Remote arm/disarm | OQ - Remote Disarming |
| Disarm after an alarm with PC software | 1 4A7 - Remote arm/disarm | OQ - Remote Disarming |
| Quick Disarm | 1 4A8 - Quick Disarm | OP - Opening Report |
| Zone Bypassed (##) | 1 57A - Zone bypass | UB - Untyped Zone Bypass |
| Zone alarm (##) | 1 13A - Burglary Alarm | BA - Burglary Alarm |
| Fire alarm (##) | 1 11A - Fire alarm | FA - Fire Alarm |
| Early to Disarm by User | 1 451 - Early to Open | OK - Early to Open |
| Late to Disarm by User | 1 452 - Late to Open | OJ - Late to Open |
| Zone alarm restore (##) | 3 13A - Burglary Alarm Restore | BH - Burglary Alarm Restore |
| Fire alarm restore (##) | 3 11A - Fire alarm Restore | FH - Fire Alarm Restore |
| 24Hr Gas alarm (##) | 1 13A - Burglary Alarm | GA - Gas Alarm |
| 24Hr Heat alarm (##) | 1 13A - Burglary Alarm | KA - Heat Alarm |
| 24Hr Water alarm (##) | 1 13A - Burglary Alarm | WA - Water Alarm |
| 24Hr Freeze alarm (##) | 1 13A - Burglary Alarm | ZA - Freeze Alarm |
| 24Hr Gas alarm restore (##) | 3 13A - Burglary Alarm Restore | GR - Gas Alarm Restore |
| 24Hr Heat alarm restore (##) | 3 13A - Burglary Alarm Restore | KR - Heat Alarm Restore |
| 24Hr Water alarm restore (##) | 3 13A - Burglary Alarm Restore | WR - Water Alarm Restore |
| 24Hr Freeze alarm restore (##) | 3 13A - Burglary Alarm Restore | ZR - Freeze Alarm Restore |
| Panic 1 - Emergency | 1 12A - Panic alarm | PA - Panic Alarm |
| Panic 2 - Medical | 1 1AA - Medical alarm | MA - Medical Alarm |
| Panic 3 - Fire | 1 115 - Pull Station | FA - Fire Alarm |
| Recent closing | 3 459 - Recent Close | CR - Recent Closing |
| Police Code | 1 139 - Burglary Alarm | BM - Burglary Alarm |
| Global zone shutdown | 1 574 - Group bypass | CG - Close Area |
| Duress alarm | 1 121 - Duress | HA - Hold-up Alarm |
| Zone shutdown (##) | 1 57A - Zone bypass | UB - Untyped Zone Bypass |

| System Event | Default Contact ID Report Code when using sections [4032] to [4037] | Default SIA Report Code when using sections [4032] to [4037] |
|--|---|--|
| Zone tampered (##) | 1 144 - Sensor tamper | TA - Tamper Alarm |
| Zone tamper restore (##) | 3 144 - Sensor tamper restore | TR - Tamper Restoral |
| Keypad Lockout | 1 421 - Access denied | JA - User Code Tamper |
| AC Failure | 1 3A1 - AC loss | AT - AC Trouble |
| Battery Failure | 1 3A9 - Battery test failure | YT - System Battery Trouble |
| Auxiliary supply trouble | 1 3AA - System trouble | YP - Power Supply Trouble |
| Bell output current limit | 1 321 - Bell 1 | YA - Bell Fault |
| Bell absent | 1 321 - Bell 1 | YA - Bell Fault |
| Clock lost | 1 626 - Time/Date inaccurate | JT - Time Changed |
| Fire loop trouble | 1 373 - Fire trouble | FT - Fire Trouble |
| TLM trouble restore | 3 351 - Telco 1 fault restore | LR - Phone Line restoral |
| AC Failure restore | 3 3A1 - AC loss restore | AR - AC Restoral |
| Battery Failure restore | 3 3A9 - Battery test restore | YR - System Battery Restoral |
| Auxiliary supply trouble restore | 3 3AA - System trouble restore | YQ - Power Supply restored |
| Bell output current limit restore | 3 321 - Bell 1 restore | YH - Bell Restored |
| Bell absent restore | 3 321 - Bell 1 restore | YH - Bell Restored |
| Clock programmed | 3 625 - Time/Date Reset | JT - Time Changed |
| Fire loop trouble restore | 3 373 - Fire trouble restore | FJ - Fire Trouble Restore |
| Combus fault | 1 333 - Expansion module failure | ET - Expansion Trouble |
| Module tamper | 1 145 - Expansion module tamper | TA - Tamper Alarm |
| Module ROM_RAM_error | 1 3A4 - Rom checksum bad | YF - Parameter Checksum Fail |
| Module TLM trouble | 1 352 - Telco 2 fault | LT - Phone Line trouble |
| Module fail to communicate to monitoring station | 1 354 - Fail to communicate | YC - Communication Fails |
| Printer fault | 1 336 - Local printer failure | VT - Printer Trouble |
| Module AC Failure | 1 3A1 - AC loss | AT - AC Trouble |
| Module battery failure | 1 3A9 - Battery test failure | YT - System Battery Trouble |
| Module Auxiliary supply trouble | 1 3AA - System trouble | YP - Power Supply Trouble |
| Combus fault restore | 3 333 - Expansion module failure restore | ER - Expansion Restoral |
| Module tamper restore | 3 145 - Expansion module tamper restore | TR - Tamper Restoral |
| Module ROM_RAM_error restore | 3 3A4 - Rom checksum bad restore | YG - Parameter Changed |
| Module TLM restore | 3 352 - Telco 2 fault restore | LR - Phone Line Restoral |
| Early to Arm by User | 3 451 - Early to Close | CK - Early to Close |
| Late to Arm by User | 3 452 - Late to Close | CJ - Late to Close |
| Zone Excluded on Force Arming | 1 57A - Zone Bypass | XW - Zone Forced |
| Zone Went Back to Arm Status | 3 57A - Zone Bypass Restore | VV - Zone Included |
| Printer fault restore | 3 336 - Local printer failure restore | VR - Printer Restore |
| Module AC restore | 3 3A1 - AC loss restore | AR - AC Restoral |
| Module battery restore | 3 3A9 - Battery test failure restore | YR - System Battery Restoral |
| Module Auxiliary supply restore | 3 3AA - System trouble restore | YQ - Power Supply Restored |
| Fail to communicate with monitoring station | 1 354 - Fail to communicate | YC - Communication Fails |
| Module RF low battery | 1 384 - RF transmitter low battery | XT - Transmitter Battery Trouble |
| Module RF supervision trouble | 1 381 - Loss of supervision - RF | US - Untype Zone Supervision |
| Module RF battery restore | 3 384 - RF transmitter battery restore | XR - Transmitter Battery Restoral |
| Module RF supervision restore | 3 381 - Supervision restore - RF | UR - Untyped Zone Restoral |
| Cold Start | 1 3A8 - System shutdown | RR - Power Up |
| Warm Start | 1 3A5 - System reset | YW - Watchdog Reset |
| Test Report engaged | 1 6A2 - Periodic test report | TX - Test Report |
| Listen-In request | 1 606 - Listen-In to follow | LF - Listen-In to follow |
| WinLoad Login request | 1 411 - Call Back Request | RB - Remote Program Begin |
| PC software communication finished | 1 412 - Successful - download access | RS - Remote Program Success |

| System Event | Default Contact ID Report Code when using sections [4032] to [4037] | Default SIA Report Code when using sections [4032] to [4037] |
|---|--|--|
| Installer on site Installer programming finished Module Fail to Communicate Restore | 1 627 - Program mode Entry 1 628 - Program mode Exit 3 354 - Fail to Communicate Restore | LB - Local Program LS - Local Program Success YK - Communication Restore |

Appendix B: Contact ID Report Code List

| CID# | Reporting Code | Prog. Value | CID# | Reporting Code | Prog. Value | CID# | Reporting Code | Prog. Value |
|---|----------------------------|-------------|---|--------------------------------|-------------|---|--|-------------|
| MEDICAL ALARMS - 100 | | | 202 | Low CO2 | 34 | 374 | Exit Error Alarm | 69 |
| 100 | Medical Alarm | 01 | 203 | Gate Valve Sensor | 35 | 375 | Panic Zone Trouble | 6A |
| 101 | Personal Emergency | 02 | 204 | Low Water Level | 36 | 376 | Hold-up Zone Trouble | 6B |
| 102 | Fail to Report In | 03 | 205 | Pump Activated | 37 | 377 | Swinger Trouble | 6C |
| FIRE ALARMS - 110 | | | 206 | Pump Failure | 38 | 378 | Cross-Zone Trouble | 6D |
| 110 | Fire Alarm | 04 | SYSTEM TROUBLES - 300 & 310 | | | SENSOR TROUBLES - 380 | | |
| 111 | Smoke | 05 | 300 | System Trouble | 39 | 380 | Sensor Trouble | 6E |
| 112 | Combustion | 06 | 301 | AC Loss | 3A | 381 | Loss of Supervision - RF | 6F |
| 113 | Water Flow | 07 | 302 | Low System Battery | 3B | 382 | Loss of Supervision - RPM | 70 |
| 114 | Heat | 08 | 303 | RAM Checksum Bad | 3C | 383 | Sensor Tamper | 71 |
| 115 | Pull Station | 09 | 304 | ROM Checksum Bad | 3D | 384 | RF Transmitter Low Battery | 72 |
| 116 | Duct | 0A | 305 | System Reset | 3E | 385 | Smoke Detector Hi Sensitivity | 73 |
| 117 | Flame | 0B | 306 | Panel Program Changed | 3F | 386 | Smoke Detector Low Sensitivity | 74 |
| 118 | Near Alarm | 0C | 307 | Self-Test Failure | 40 | 387 | Intrusion Detector Hi Sensitivity | 75 |
| PANIC ALARMS - 120 | | | 308 | System Shutdown | 41 | 388 | Intrusion Detector Low Sensitivity | 76 |
| 120 | Panic Alarm | 0D | 309 | Battery Test Failure | 42 | 389 | Sensor Self-Test Failure | 77 |
| 121 | Duress | 0E | 310 | Ground Fault | 43 | 391 | Sensor Watch Trouble | 78 |
| 122 | Silent | 0F | 311 | Battery Missing/Dead | 44 | 392 | Drift Compensation Error | 79 |
| 123 | Audible | 10 | 312 | Power Supply Over Current | 45 | 393 | Maintenance Alert | 7A |
| 124 | Duress-Access Granted | 11 | 313 | Engineer Reset | 46 | OPEN/CLOSE - 400 | | |
| 125 | Duress-Egress Granted | 12 | SOUNDER/RELAY TROUBLES - 320 | | | 400 | Open/Close | 7B |
| BURGLAR ALARMS - 130 | | | 320 | Sounder Relay | 47 | 401 | Open/Close by User | 7C |
| 130 | Burglary | 13 | 321 | Bell 1 | 48 | 402 | Group Open/Close | 7D |
| 131 | Perimeter | 14 | 322 | Bell 2 | 49 | 403 | Automatic Open/Close | 7E |
| 132 | Interior | 15 | 323 | Alarm Relay | 4A | 406 | Cancel | 7F |
| 133 | 24-Hour | 16 | 324 | Trouble Relay | 4B | 407 | Remote Arm/Disarm | 80 |
| 134 | Entry/Exit | 17 | 325 | Reversing Relay | 4C | 408 | Quick Arm | 81 |
| 135 | Day/Night | 18 | 326 | Notification Appliance chk. #3 | 4D | 409 | Keypad Open/Close | 82 |
| 136 | Outdoor | 19 | 327 | Notification Appliance chk. #4 | 4E | REMOTE ACCESS - 410 | | |
| 137 | Tamper | 1A | SYSTEM PERIPHERAL TROUBLES - 330 & 340 | | | 411 | Callback Request Made | 83 |
| 138 | Near Alarm | 1B | 330 | System Peripheral | 4F | 412 | Successful - Download Access | 84 |
| 139 | Intrusion Verifier | 1C | 331 | Polling Loop Open | 50 | 413 | Unsuccessful Access | 85 |
| GENERAL ALARMS - 140 | | | 332 | Polling Loop Short | 51 | 414 | System Shutdown | 86 |
| 140 | General Alarm | 1D | 333 | Expansion Module Failure | 52 | 415 | Dialer Shutdown | 87 |
| 141 | Polling Loop Open | 1E | 334 | Repeater Failure | 53 | 416 | Successful Upload | 88 |
| 142 | Polling Loop Short | 1F | 335 | Local Printer Paper Out | 54 | ACCESS CONTROL - 420 | | |
| 143 | Expansion Module Failure | 20 | 336 | Local Printer Failure | 55 | 421 | Access Denied | 89 |
| 144 | Sensor Tamper | 21 | 337 | Exp. Module DC Low | 56 | 422 | Access Report By User | 8A |
| 145 | Expansion Module Tamper | 22 | 338 | Exp. Module Low Batt | 57 | 423 | Forced Access | 8B |
| 146 | Silent Burglary | 23 | 339 | Exp. Module Reset | 58 | 424 | Egress Denied | 8C |
| 147 | Sensor Supervision Failure | 24 | 341 | Exp. Module Tamper | 59 | 425 | Egress Granted | 8D |
| 24-HOUR NON-BURGLARY - 150 & 160 | | | 342 | Exp. Module AC Lost | 5A | 426 | Access Door Propped Open | 8E |
| 150 | 24-Hour Non-Burglary | 25 | 343 | Exp. Module Self-Test Fail | 5B | 427 | Access Point Door Status Monitor trouble | 8F |
| 151 | Gas Detected | 26 | 344 | RF Receiver Jam Detected | 5C | 428 | Access Point Request to Exit | 90 |
| 152 | Refrigeration | 27 | COMMUNICATION TROUBLES - 350 & 360 | | | 429 | Access Program Mode Entry | 91 |
| 153 | Loss of Heat | 28 | 350 | Communication | 5D | 430 | Access Program Mode Exit | 92 |
| 154 | Water Leakage | 29 | 351 | Telco Fault 1 | 5E | 431 | Access Threat Level Change | 93 |
| 155 | Foil Break | 2A | 352 | Telco Fault 2 | 5F | 432 | Access Relay/Trigger Fail | 94 |
| 156 | Day Trouble | 2B | 353 | Long Range Radio | 60 | 433 | Access RTE Shunt | 95 |
| 157 | Low Bottled Gas Level | 2C | 354 | Fail to Communicate | 61 | 434 | Access DSM Shunt | 96 |
| 158 | High Temperature | 2D | 355 | Loss of Radio Supervision | 62 | 441 | Armed Stay | 97 |
| 159 | Low Temperature | 2E | 356 | Loss of Central Polling | 63 | 442 | Keypad Armed Stay | 98 |
| 161 | Loss of Air Flow | 2F | 357 | Long Range Radio VSWR problem | 64 | SPECIAL TROUBLES - 450 & 460 | | |
| 162 | Carbon Monoxide Detected | 30 | PROTECTION LOOP TROUBLES - 370 | | | 450 | Exception Open/Close | 99 |
| 163 | Tank Level | 31 | 370 | Protection Loop | 65 | 451 | Early Open/Close | 9A |
| FIRE SUPERVISORY - 200 & 210 | | | 371 | Protection Loop Open | 66 | 452 | Late Open/Close | 9B |

| CID# | Reporting Code | Prog. Value | CID# | Reporting Code | Prog. Value | CID# | Reporting Code | Prog. Value |
|-------------------------------------|---|-------------|---|--|-------------|------|----------------------------|-------------|
| 200 | Fire Supervisory | 32 | 372 | Protection Loop short | 67 | 453 | Failed to Open | 9C |
| 201 | Low Water Pressure | 33 | 373 | Fire Trouble | 68 | 454 | Failed to Close | 9D |
| 455 | Auto-Arm Failed | 9E | COMMUNICATION DISABLES - 550 & 560 | | | 609 | Video Xmitter Active | C5 |
| 456 | Partial Arm | 9F | 551 | Dialer Disabled | B3 | 611 | Point Test Ok | C6 |
| 457 | User Exit Error | A0 | 552 | Radio Transmitter Disabled | B4 | 612 | Point Not Tested | C7 |
| 458 | User on Premises | A1 | BYPASSES - 570 | | | 613 | Intrusion Zone Walk Tested | C8 |
| 459 | Recent Close | A2 | 570 | Zone Bypass | B5 | 614 | Fire Zone Walk Tested | C9 |
| 461 | Wrong Code Entry | A3 | 571 | Fire Bypass | B6 | 615 | Panic Zone Walk Tested | CA |
| 462 | Legal Code Entry | A4 | 572 | 24-Hour Zone Bypass | B7 | 616 | Service Request | CB |
| 463 | Re-arm after Alarm | A5 | COMMUNICATION DISABLES - 550 & 560 | | | 621 | Event Log Reset | CC |
| 464 | Auto-Arm Time Extended | A6 | 573 | Burglary Bypass | B8 | 622 | Event Log 50% Full | CD |
| 465 | Panic Alarm Reset | A7 | 574 | Group Bypass | B9 | 623 | Event Log 90% Full | CE |
| 466 | Service On/Off Premises | A8 | 575 | Swinger Bypass | BA | 624 | Event Log Overflow | CF |
| SOUNDER RELAY DISABLES - 520 | | | 576 | Access Zone Shunt | BB | 625 | Time/Date Reset | D0 |
| 520 | Sounder/Relay Disabled | A9 | 577 | Access Point Bypass | BC | 626 | Time/Date Inaccurate | D1 |
| 521 | Bell 1 Disable | AA | TEST/MISC. - 600 | | | 627 | Program Mode Entry | D2 |
| 522 | Bell 2 Disable | AB | 601 | Manual Trigger Test | BD | 628 | Program Mode Exit | D3 |
| 523 | Alarm Relay Disable | AC | 602 | Periodic Test Report | BE | 629 | 32 Hour Event Log Marker | D4 |
| 524 | Trouble Relay Disable | AD | 603 | Periodic RF Transmission | BF | 630 | Schedule Change | D5 |
| 525 | Reversing Relay Disable | AE | 604 | Fire Test | C0 | 631 | Exception Schedule Change | D6 |
| 526 | Notification Appliance chk. #3 Disabled | AF | 605 | Status Report to Follow | C1 | 632 | Access Schedule Change | D7 |
| 527 | Notification Appliance chk. #4 Disabled | B0 | 606 | Listen-in to Follow | C2 | 654 | System Inactivity | D8 |
| 531 | Module Added | B1 | 607 | Walk Test Mode | C3 | | | |
| 532 | Module Removed | B2 | 608 | Periodic Test - System Trouble Present | C4 | | | |

Appendix C: Keypad Installation Instructions

Connecting the Keypads

The keypads are connected to the control panel's combus in a star and/or daisy chain configuration. Connect the four terminals labeled red, black, green and yellow of each keypad to the corresponding terminals on the control panel.

Connecting Keypad Zones

Each keypad has one hardwired input terminal, allowing you to connect one detector or door contact directly to it. Connect the device to the keypad's input terminal. In order to communicate its status to the control panel, the keypad's input must be assigned to a zone in the control panel and the zone's parameters must be defined.

Programmable Output

Each keypad has one on-board PGM. Upon activation, the PGM can provide 50mA to any device connected to it. If the current drawn is to exceed the current limit, a relay should be connected to the PGM.

Keypad Specific Instructions

C.0.1 Memory Key Connection

A memory key can be used to download programming to the K641 and K641R keypads.

C.0.2 Memory Key

SECTIONS [510] AND [520]

Download information using the memory key (PMC-4).

| | |
|-----------------|---|
| Section [510] = | Download all from the memory key (LCD keypad sections [001] to [396] and all messages) to the LCD keypad. |
| Section [520] = | Copy the LCD keypad sections [001] to [396] and all messages to the memory key. |

C.0.3 Download Contents of Memory Key to Keypad

SECTION [510]

1. Insert the memory key into the keypad's connector labelled "KEY."
2. To download the contents of the memory key, enter the keypad's programming mode and enter section [510].
3. When the keypad emits a confirmation beep, wait 5 seconds and remove the memory key after the second confirmation beep.

C.0.4 Copy the Keypad Contents to the Memory Key

SECTION [520]

1. Insert the memory key onto the keypad's connector labelled "KEY." Ensure that the write protect jumper is ON.
2. To copy the contents to the memory key, enter the keypad's programming mode and enter section [520].

3. After the confirmation beep, wait 5 seconds and remove the memory key after the second confirmation beep. Set the memory key's jumper to OFF if you do not wish to accidentally overwrite its contents.

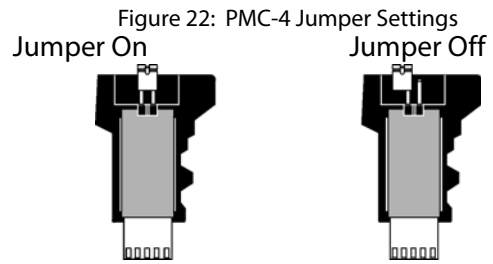

K641R Access Control Connection

Figure 23: Typical Access Control Installation

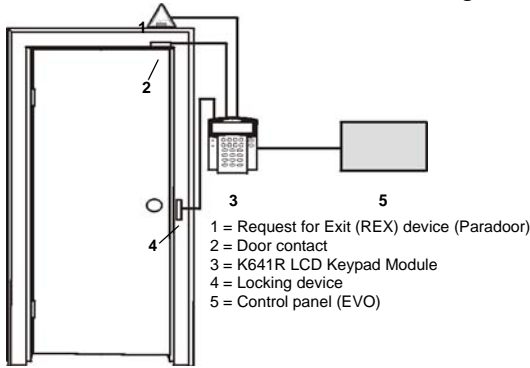

Figure 24: Access Control Overview

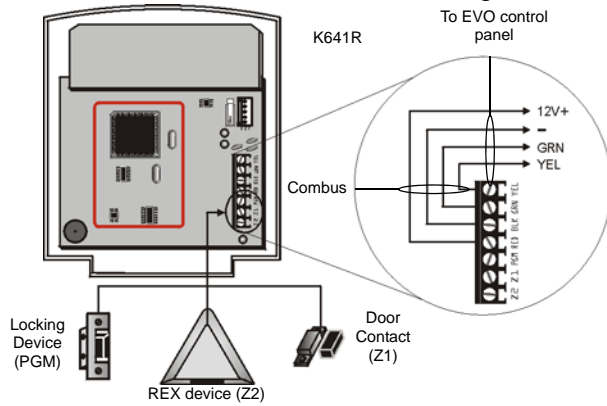
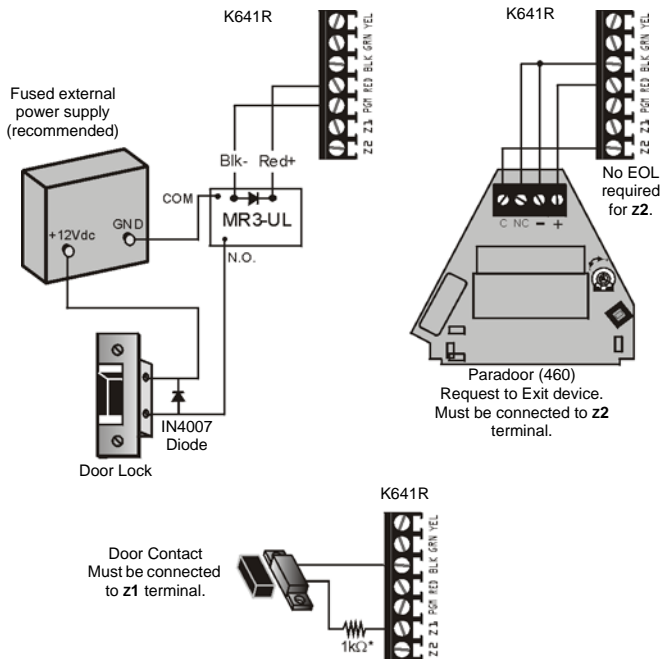

Figure 25: Access Control Connections



* Follows control panel's EOL definition.



If a door contact is not being used, install a jumper or a 1kΩ resistor across the BLK and Z1 terminals depending on the control panel's EOL definition.

If the REX (Request for Exit) device is not being used, place a jumper across the BLK and Z2 terminals.

Programming

C.0.5 Entering Module Programming Mode

The keypad is programmed through the control panel. To do so, you must first enter Module Programming Mode:

1. From Normal Mode press and hold the **[0]** key.
2. Enter the **[INSTALLER CODE]** (Default: 000000).
3. Enter section **[4003]**.
4. Enter the keypad's 8-digit **[SERIAL NUMBER]**.
5. Enter the 3-digit **[SECTION]** you want to program.
6. Enter the required **[DATA]**.

The control panel will then redirect all programming to the selected keypad. Every time the **[CLEAR]** key is pressed it will revert to the preceding step, unless entering in data in which case it will erase the current data entry. Please note that the serial number is located on the keypad's PC board or enter section **[000]** in Step 3 to view the keypad's serial number.

C.0.6 Module Broadcast

The control panel's Module Broadcast feature can be used to copy the contents of one keypad to one or more keypads.

1. From Normal Mode press and hold the **[0]** key.
2. Enter **[INSTALLER CODE]** (Default: 000000).
3. Enter section **[4004]**.
4. Enter the **[SERIAL #]** of the source keypad. The *source* is the programmed keypad whose data you want to copy to other keypads.
5. Enter the **[SERIAL #]** of the destination keypads. The *destination* is the keypad(s) you want to program with the source's data. If you want to program more than one keypad with the source's data, enter the serial numbers of the keypads one at a time.
6. Once you have entered the serial numbers of the keypads you want to program, press the **[ACC]** key.

Message Programming K641/K641R

SECTIONS **[101]** TO **[148]**, **[200]** TO **[204]**, AND **[301]** TO **[396]**

Each section contains one message with a maximum of 16 characters. For more details and to record any changes, use the *Digiplex Modules' Programming Guide*.



Note: The EVO control panel has up to 8 partitions, 96 zones and up to 999 user codes. The LCD keypad only allows you to program the messages for up to 4 partitions, 48 zones and 96 user codes. The rest of the messages can be programmed directly into the EVO control panel. Refer to the EVO Reference & Installation Manual and to the EVO Programming Guide for more details.

Section [101] to [148] = "Zone 01" to "Zone 48" respectively
 Section [200] = "Paradox Security"
 Section [201] to [204] = "First Area", "Second Area", "Third Area",
 and "Fourth Area" respectively
 Section [301] to [396] = "Code 01" to "Code 96" respectively

After entering the section corresponding to the desired message, use the Message Programming Keys (refer to *Table 8*) and *Table 7* on page 93 to change the message to suit your installation needs.

K641 Programming

C.0.7 Partition Assignment

SECTION [001]: OPTIONS [1] TO [8]

To assign the keypad to a partition, simply enable the option that corresponds to the desired partition. By default, partitions 1 to 8 are enabled.

C.0.8 Display Access Code Entry

SECTION [003]: OPTION [1]

Option [1] OFF = Digits are replaced by a * (default)
 Option [1] ON = Access Code digits will be displayed

C.0.9 Display Exit Delay Timer

SECTION [003]: OPTION [2]

Option [2] OFF= Will not display Exit Delay timer (default)
 Option [2] ON= LCD screen will display Exit Delay timer

C.0.10 Display Entry Delay Timer

SECTION [003]: OPTION [3]

Option [3] OFF= Will not display the Entry Delay Timer (default)
 Option [3] ON= LCD screen will display Entry Delay Timer

C.0.11 Confidential Mode

SECTION [003]: OPTIONS [4] AND [5]

In Confidential Mode, all LEDs will turn off and the display will change until either a button is pressed or an access code is entered.

Option [4] OFF = Normal Mode (default)
 Option [4] ON = Confidential Mode
 Option [5] OFF = LCD screen activated by entering an access code (default)
 Option [5] ON = LCD screen activated by pressing a button

Figure 26: LCD Screen

in Normal Mode:

in Confidential Mode:

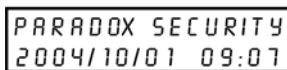

PARADOX SECURITY
2004/10/01 09:07



CONFIDENTIAL
2004/10/01 09:07

C.0.12 Confidential Mode Timer

SECTION [007]

Section [007] determines the amount of time without action before the keypad enters Confidential Mode. The Confidential Mode Timer can be set from 005 seconds to 255 seconds. Default: 120 seconds.

C.0.13 Time Display Option

SECTION [003]: OPTION [8]

Option [8] OFF = Date displayed as yy/mm/dd (default)
 Option [8] ON = Date displayed as dd/mm/yy

C.0.14 Muting

SECTION [004]: OPTION [1]

Option [1] OFF = Audible sounds (default)
Option [1] ON = Mute

C.0.15 Beep on Exit Delay

SECTION [004]: OPTION [2]

Option [2] OFF= Exit Delay beep disabled
Option [2] ON= Exit Delay beep enabled (default)

C.0.16 Chime on Zone Closure

SECTION [004]: OPTION [4]

Option [4] OFF = Chime on Zone Closure disabled (default)
Option [4] ON = Chime on Zone Closure enabled

C.0.17 Beep on Trouble

SECTION [005]: OPTIONS [1] TO [4]

Option [1] OFF = Beep disabled: System Troubles and Clock Loss (default)
Option [1] ON = Beep enabled: System Troubles and Clock Loss

Option [2] OFF = Beep disabled: Communicator Troubles (default)
Option [2] ON = Beep enabled: Communicator Troubles

Option [3] OFF = Beep disabled: Module and Bus Troubles (default)
Option [3] ON = Beep enabled: Module and Bus Troubles

Option [4] OFF = Beep disabled: all Zone Troubles (default)
Option [4] ON = Beep enabled: all Zone Troubles

C.0.18 Keypad Tamper Enable

SECTION [006]: OPTION [5]

Option [5] OFF = Keypad's tamper is disabled (default)
Option [5] ON = Keypad's tamper is enabled

C.0.19 Combustion Voltmeter

1. From Normal Mode press and hold the [0] key.
2. Enter the [INSTALLER CODE] (Default: 000000).
3. Press [ACC].



Note:The voltage may drop during the control panel battery test.

Programmable Output Options

C.0.20 PGM State

SECTION [006]: OPTION [1]

Option [1] OFF= PGM is Normally Open (default)
Option [1] ON= PGM is Normally Closed



Note:The PGM can provide 50mA to any device connected to it.

C.0.21 PGM Deactivation Mode

SECTION [006]: OPTION [2]

- Option [2] OFF = Deactivates on PGM Deactivation Event (default)
- Option [2] ON = PGM will deactivate according to the PGM Timer

C.0.22 PGM Base Time

SECTION [006]: OPTION [3]

- Option [3] OFF = PGM Base Time is 1 second (default)
- Option [3] ON = PGM Base Time is 1 minute

C.0.23 PGM Override

SECTION [006]: OPTION [4]

When the PGM override is enabled, the keypad's on-board PGM will ignore PGM Activation Events (*section C.0.25*), PGM Deactivation Events (*section C.0.26*), and PGM Timers (*section C.0.24*). It will remain in its normal state until the PGM Override is disabled. This option may be used to test the PGM connections.

- Option [4] OFF = PGM Override disabled (default)
- Option [4] ON = PGM Override enabled

C.0.24 PGM Timer

SECTION [008]

The value programmed in section [008] represents how long the PGM will remain in its opposite state after being activated. To program the timer, enter a 3-digit decimal value (000 to 255) in section [008]. Default: 5 seconds.

C.0.25 PGM Activation Event

SECTIONS [009] TO [012]

Enter the sections that correspond to the Event Group, Feature Group, Start # and End # of the PGM and enter the required data.

| | Event Group | Feature Group | Start # | End # |
|-----|-------------|---------------|---------|-------|
| PGM | [009] | [010] | [011] | [012] |

C.0.26 PGM Deactivation Event

SECTIONS [013] TO [016]

If the PGM Deactivation Option is set to follow the PGM Deactivation event, the PGM will return to its normal state when the event programmed in sections [013] to [016] occurs.

Enter the sections that correspond to the Event Group, Feature Group, Start # and End # of the PGM and enter the required data.

| | Event Group | Feature Group | Start # | End # |
|-----|-------------|---------------|---------|-------|
| PGM | [013] | [014] | [015] | [016] |

K641R Programming

C.0.27 Partition Assignment

SECTION [001]: OPTIONS [1] TO [8]

To assign the keypad to a partition, enable the option that corresponds to the desired partition. *By default, partitions 1 to 8 are enabled.*

C.0.28 Display Access Code Entry

SECTION [003]: OPTION [1]

- Option [1] OFF=Digits are replaced by a "*" (default)
- Option [1] ON=Access Code digits will be displayed

C.0.29 Display Exit Delay Timer

SECTION [003]: OPTION [2]

Option [2] OFF=Will not display Exit Delay timer (default)

Option [2] ON=LCD screen will display Exit Delay timer

C.0.30 Display Entry Delay Timer

SECTION [003]: OPTION [3]

Option [3] OFF=Will not display the Entry Delay Timer (default)

Option [3] ON=LCD screen will display Entry Delay Timer

C.0.31 Confidential Mode

SECTION [003]: OPTIONS [4] AND [5]

Section [003]:

Option [4] OFF=Normal Mode (default)

Option [4] ON=Confidential Mode

Option [5] OFF=LCD screen activated by entering an access code (default)

Option [5] ON=LCD screen activated by pressing a button

C.0.32 Confidential Mode Timer

SECTION [007]

Section [007] determines the amount of time without action before the keypad enters Confidential Mode. The Confidential Mode Timer can be set from 005 seconds to 255 seconds. *Default: 120 secs.*

C.0.33 Time Display Option

SECTION [003]: OPTION [8]

Option [8] OFF=Date displayed as yy/mm/dd (default)

Option [8] ON=Date displayed as dd/mm/yy

C.0.34 Muting

SECTION [004]: OPTION [1]

Option [1] OFF=Audible sounds (default)

Option [1] ON=Mute

C.0.35 Beep on Exit Delay

SECTION [004]: OPTION [2]

Option [2] OFF=Exit Delay beep disabled

Option [2] ON=Exit Delay beep enabled (default)

C.0.36 Chime on Zone Closure

SECTION [004]: OPTION [4]

Option [4] OFF=Chime on Zone Closure disabled (default)

Option [4] ON=Chime on Zone Closure enabled

C.0.37 Beep on Trouble

SECTION [005]: OPTIONS [1] TO [4]

Option [1] OFF=Beep disabled: System Troubles and Clock Loss

Option [1] ON=Beep enabled: System Troubles and Clock Loss

Option [2] OFF=Beep disabled: Communicator Troubles

Option [2] ON=Beep enabled: Communicator Troubles

Option **[3]** OFF=Beep disabled: Module and Combus Troubles

Option **[3]** ON=Beep enabled: Module and Combus Troubles

Option **[4]** OFF=Beep disabled: all Zone Troubles

Option **[4]** ON=Beep enabled: all Zone Troubles

C.0.38 Keypad Tamper Enable

SECTION [006]: OPTION [5]

Option **[5]** OFF=Keypad's tamper is disabled (default)

Option **[5]** ON=Keypad's tamper is enabled

C.0.39 Time Format

SECTION [005]: OPTION [7]

Option **[7]** OFF=Time uses the International time format (default).

Option **[7]** ON=Time uses the US time format.

C.0.40 Combus Voltmeter

1. From Normal Mode press and hold the **[0]** key.

2. Enter the **[INSTALLER CODE]** (by default 000000).

3. Press **[ACC]**.



The voltage may drop during the control panel battery test.

Access Control Options

C.0.41 Assigning Doors To Partitions

SECTION [002]: OPTIONS [1] TO [8]

The Access Control door can be assigned to one or more partition(s) in the alarm system. This means that the actions performed with the Access Control Card will be directly linked to the partition(s) assigned to that door.

Option **[1]** ON =Door assigned to Partition 1 (default)

Option **[2]** ON =Door assigned to Partition 2

Option **[3]** ON=Door assigned to Partition 3

Option **[4]** ON =Door assigned to Partition 4

Option **[5]** ON=Door assigned to Partition 5

Option **[6]** ON=Door assigned to Partition 6

Option **[7]** ON=Door assigned to Partition 7

Option **[8]** ON=Door assigned to Partition 8

OFF = Access Control Cards will not be able to arm and/or disarm partitions from the door's reader

C.0.42 Unlock on REX (Request For Exit)

SECTION [006]: OPTION [8]

Option **[8]** OFF=Unlock on REX disabled (default)

Option **[8]** ON=Unlock on REX enabled

C.0.43 Door Unlocked Period

SECTION [008]

Enter any value between 001 and 255 to determine the seconds the door can remain unlocked. *Default = 5 secs.*

C.0.44 Door Unlocked Period Extension

SECTION [009]

The Door Unlocked Period Extension is the amount of time added to the Door Unlocked Period in section [008], which leaves the door unlocked longer. This will allow those with this feature enabled on their User Access Codes extra time to enter. Enter any value between 001 and 255 to determine the number of seconds to be added to the time programmed in section [008]. *Default = 15 secs.*

C.0.45 Relock Door

SECTION [006]: OPTION [6]

Option [6] OFF=Locking device latches immediately (default)

Option [6] ON=Locking device latches when door closes

C.0.46 Door Unlocked Schedule

SECTION [017]

The Door Unlocked Schedule determines the hours, days, and holidays that the door will remain unlocked. Program the Start Time and End Time according to the 24-hour clock within the same day. Use *Feature Select Programming* to set the options representing the Days.

Table 16: Door Unlocked Schedule

| Option | Day | Option | Day |
|--------|---------------|--------|--------------|
| [1] | Sunday (S) | [5] | Thursday (T) |
| [2] | Monday (M) | [6] | Friday (F) |
| [3] | Tuesday (T) | [7] | Saturday (S) |
| [4] | Wednesday (W) | [8] | Holidays (H) |

C.0.47 Card Activates Door Unlocked Schedule

SECTION [006]: OPTION [1]

Option [1] OFF=The Schedule activates without Card

Option [1] ON=Card activates Door Unlocked Schedule (default)

C.0.48 Door Left Open Access Alarm

SECTION [006]: OPTION [2]

Table 17: Door Left Open Access Alarm

| Section |
|---|
| [004] Option [3] Door Left Open Pre-alarm Option [5] Door Left Open Alarm Option [6] Door Left Open Alarm follows |
| [010] Door Left Open Interval |
| [011] Door Left Open Pre-alarm Timer |
| [012] Beep Timer for Door Left Open Alarm |

Option [2] OFF=Door Left Open Alarm won't be generated (default)

Option [2] ON=Door Left Open Alarm is enabled

C.0.49 Door Left Open Interval Before Access Alarm

SECTION [010]

Enter any value between 001 and 255 to determine the number of seconds the door may remain open before the Access Alarm is triggered. *Default = 60 secs.*

C.0.50 Door Left Open Pre-Alarm

SECTION [004]: OPTION [3]

Program the Pre-Alarm timer in section [011].

Option [3] OFF=The Pre-Alarm will not be generated

Option **[3]** ON=Pre-Alarm is enabled (default)

C.0.51 Door Left Open Pre-Alarm Timer

SECTION [011]

This timer will trigger the Door Left Open Pre-Alarm before the end of the Door Left Open Interval. Enter any value between 001 and 255 to determine the seconds before the expiry of the Door Left Open Interval that the reader will beep. *Default = 15 seconds.*

C.0.52 Door Left Open Alarm Feedback

SECTION [004]: OPTIONS [5] AND [6]

Option **[5]** OFF=The Door Left Open Alarm is silent

Option **[5]** ON=The Door Left Open Alarm is audible (default)

If option **[5]** is enabled:

Option **[6]** OFF=Beep as long as the Door Left Open Alarm is occurring (default)

Option **[6]** ON=Door Left Open Alarm follows Beep Timer (section [012])

C.0.53 Beep Timer For Door Left Open Alarm

SECTION [012]

Enter any value between 001 and 255 to determine the number of seconds the Access Alarm will beep. *Default = 5 seconds.*

C.0.54 Door Forced Open Access Alarm

SECTION [006]: OPTION [3]

When the Door Forced Open Alarm is disabled, the following sections are also disabled:

Table 18: Door Forced Open Access Alarm

Section

- [004]** Option **[7]** Door Forced Open Alarm
Option **[8]** Door Forced Open Alarm follows
- [013]** Beep Timer for Door Forced Open Alarm

Option **[3]** OFF=Door Forced Open Alarm is disabled (default)

Option **[3]** ON=Door Forced Open Alarm is enabled

C.0.55 Door Forced Open Feedback

SECTION [004]: OPTIONS [7] AND [8]

Option **[7]** OFF=Door Forced Open Alarm is silent

Option **[7]** ON=Door Forced Open Alarm is audible (default)

If option **[7]** is enabled:

Option **[8]** OFF=Will beep as long as Door Forced Open Alarm is occurring (default)

Option **[8]** ON=Door Forced Open Alarm follows Beep Timer. (section [013])

C.0.56 Beep Timer For Door Forced Open Alarm

SECTION [013]

Enter any value between 001 and 255 to determine the number of seconds the Door Forced Open Alarm will beep. *Default = 5 seconds.*

C.0.57 PIN Entry ON Keypad

SECTION [006]: OPTION [4]

If the *Card and Code Access* option is enabled in the EVO control panel, users must present their access control card and then enter their PIN on the K641R keypad to gain access. The PIN Entry on Keypad option cannot be turned ON and will always be OFF.

DGP2-648BL Programming

C.0.58 Partition Display

Section [001] to [008]

You can program the LED keypad to display up to four partitions. Sections [001] to [008] correspond to partitions 1 to 8. The LED numbers A1 to A4 are assigned values 001 to 004 (*Figure 28*). To assign a display number to a partition, choose a section number from [001] to [008] and assign it a value between 001 and 004 which represents LED numbers A1 to A4 respectively

Figure 27: :: Keypad Overview

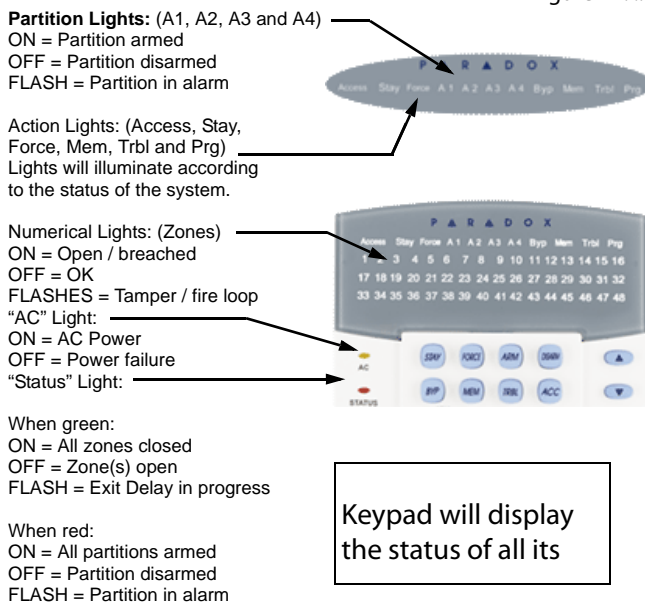

[ENTER] Saves current data and exits current menu.

Figure 28: : LED Partition Display

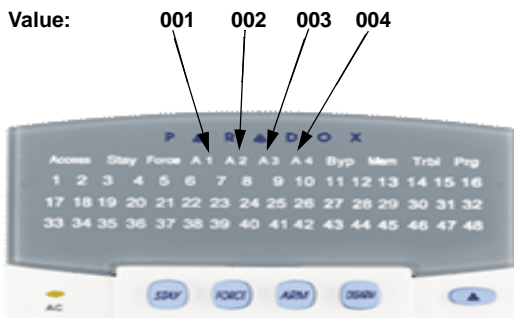

Do not assign the same display number to more than one section. For example, you cannot assign value 002 to sections [003] and [004]. The rejection beep will remind you that a selected display number is already assigned to another section.

C.0.59 Zone Display

Section [101] To [196]

You can program the keypad to display up to a total of 48. Sections **[101]** to **[196]** correspond to zones 1 to 96 respectively. These zones are displayed on LED numbers 1 to 48 and are assigned values 001 to 048.



Do not assign more than one LED number to a zone. For example, you cannot assign LED number 33 to zones 21 and 28. The rejection beep will remind you that a selected LED number is already assigned to another section.



Every time the **[CLEAR]** key is pressed it will revert to the preceding step, unless entering in data in which case it will erase the current entry.

C.0.60 Section Reset

Section [040]

This section resets zone display sections **[101]** to **[196]** to default settings. Enter **[040]** to perform the reset.

C.0.61 Confidential Mode

Section [009] Option [1]

In Confidential Mode all LEDs will turn off until either a button is pressed or an access code is entered.

Option **[1]** OFF = Disabled (default).

Option **[1]** ON = Enabled.

C.0.62 Exit Confidential Mode

Section [009] Option [2]

Option **[2]** ON = Exit Confidential Mode by entering an access code.

Option **[2]** OFF = Exit Confidential Mode by pressing a button (default).



Option **[2]** must be set to ON on UL listed systems.

Option **[2]** will only work if option **[1]** is enabled.

C.0.63 Confidential Mode Timer

Section [012]

Section [012] determines the amount of time without action before the keypad enters Confidential Mode. The Confidential Mode Timer can be set from 005 seconds to 255 seconds. *Default: 120 seconds*

C.0.64 Muting

Section [009] Option [3]

Option [3] OFF = Audible sounds (default).

Option [3] ON = Mute.

C.0.65 Beep on Exit Delay

Section [009] Option [4]

Option [4] OFF = Exit Delay beep disabled.

Option [4] ON = Exit Delay beep enabled (default).

C.0.66 Chime on Zone Closure

Section [009] Option [5]

Option [5] OFF = Chime on Zone Closure disabled (default).

Option [5] ON = Chime on Zone Closure enabled.

C.0.67 Beep on Trouble

Section [010] Options [1] To [4]

System Troubles / Clock Loss

Option [1] OFF = Disabled (default).

Option [1] ON = Enabled.

Communicator Troubles

Option [2] OFF = Disabled (default).

Option [2] ON = Enabled.

Module / Communication Bus Troubles

Option [3] OFF = Disabled (default).

Option [3] ON = Enabled.

Zone Troubles

Option [4] OFF = Disabled (default).

Option [4] ON = Enabled.

C.0.68 Keypad Anti-tamper Enable

Section [011] Option [5]

Option [5] OFF = Keypad's anti-tamper is disabled (default).

Option [5] ON = Keypad's anti-tamper is enabled.

Programmable Output Options

C.0.69 PGM State

SECTION [011] OPTION [1]

The PGM is limited to 50mA.

Option [5] OFF = PGM is Normally Open (default).

Option [5] ON = PGM is Normally Closed.

C.0.70 PGM Activation Event

SECTION [014] to [017]

Enter the sections that correspond to the **EVENT GROUP**, **FEATURE GROUP**, **START #** and **END #** of the PGM and enter the required data.

| | Event group | Feature group | Start # | End # |
|-----|--------------------|----------------------|----------------|--------------|
| PGM | [014] | [015] | [016] | [017] |

C.0.71 PGM Deactivation Event

SECTION [018] to [021]

If the PGM Deactivation Option is set to follow the PGM Deactivation Event, the PGM will return to its normal state when the event programmed in sections [018] to [021] occurs. Enter the sections that correspond to the **EVENT GROUP**, **FEATURE GROUP**, **START #** and **END #** of the PGM and enter the required data.

| | Event group | Feature group | Start # | End # |
|-----|--------------------|----------------------|----------------|--------------|
| PGM | [018] | [019] | [020] | [021] |

C.0.72 PGM Deactivation Mode

SECTION [011] Option [2]

Option [2] OFF = Deactivation as per PGM Deactivation Event (default).

Option [2] ON = PGM will deactivate according to the PGM Timer.

C.0.73 PGM Base Time

SECTION [011] Option [3]

Option [3] OFF = PGM Base Time is 1 second (default).

Option [3] ON = PGM Base Time is 1 minute.

C.0.74 PGM Timer

SECTION [013]

To program the timer, enter a 3-digit decimal value (001 to 255) in section [013].

C.0.75 PGM Test

SECTION [030]

Use this section to initiate a PGM test, which will activate the PGM for 8 seconds. Enter section [030] to activate this test.

Appendix D: Guidelines for Locating Smoke Detectors and CO Detectors

The following information is for general guidance only and it is recommended that local fire codes and regulations be consulted when locating and installing smoke and CO alarms.

Smoke Detectors

Experiments with typical fires in homes indicate that detectable quantities of smoke precede detectable levels of heat in most cases. For these reasons, smoke alarms should be installed outside of each sleeping area and on each storey of the home.

The following information is for general guidance only and it is recommended that local fire codes and regulations be consulted when locating and installing smoke alarms. It is recommended that additional smoke alarms beyond those required for minimum protection be installed.

Additional areas that should be protected include: the basement; bedrooms, especially where smokers sleep; dining rooms; furnace and utility rooms; and any hallways not protected by the required units. On smooth ceilings, detectors may be spaced 9.1m (30 feet) apart as a guide. Other spacing may be required depending on ceiling height, air movement, the presence of joists, un-insulated ceilings, etc.

Consult National Fire Alarm Code NFPA 72, CAN/ULC-S553-02 or other appropriate national standards for installation recommendations. •

Warning: Do not locate smoke detectors at the top of peaked or gabled ceilings; the dead air space in these locations may prevent the unit from detecting smoke. • Avoid areas with turbulent air flow, such as near doors, fans or windows. Rapid air movement around the detector may prevent smoke from entering the unit. • Do not locate detectors in areas of high humidity. • Do not locate detectors in areas where the temperature rises above 38 ° or below 5° C

Smoke detectors should always be installed in USA in accordance with Chapter 11 of NFPA 72, the National Fire Alarm Code: 11.5.1.1.

Where required by applicable laws, codes, or standards for a specific type of occupancy, approved single- and multiple-station smoke alarms shall be installed as follows:

1. In all sleeping rooms and guest rooms.
2. Outside of each separate dwelling unit sleeping area, within 6.4 m (21 ft) of any door to a sleeping room, the distance measured along a path of travel.
3. On every level of a dwelling unit, including basements.
4. On every level of a residential board and care occupancy (small facility), including basements and excluding crawl spaces and unfinished attics.
5. In the living area(s) of a guest suite.
6. In the living area(s) of a residential board and care occupancy (small facility).

CO detectors

Install one CO detector in each room that has a fuel burning appliance.

Make sure the alarm can be heard in the sleeping quarters of the building.

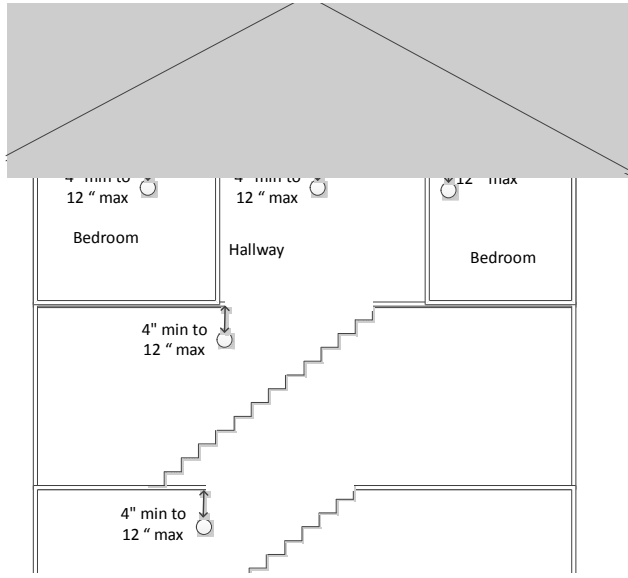

Figure 29 – Recommendations for Smoke Detector Locations

Appendix E: Fire Escape Planning

The manual should include an "Emergency evacuation plan" – this can be copied or rewritten based on the instructions of NFPA in the following link:

C) Information on establishing a residential emergency evacuation plan in the event of a fire.

Pull together everyone in your household and make a plan. Walk through your home and inspect all possible exits and escape routes. Households with children should consider drawing a floor plan of your home, marking two ways out of each room, including windows and doors. Also, mark the location of each smoke alarm. For easy planning, download NFPA's escape planning grid (PDF, 1.1 MB). This is a great way to get children involved in fire safety in a non-threatening way.

- Install smoke alarms in every sleeping room, outside each sleeping area and on every level of the home. NFPA 72, National Fire Alarm Code® requires interconnected smoke alarms throughout the home. When one sounds, they all sound.

- Everyone in the household must understand the escape plan. When you walk through your plan, check to make sure the escape routes are clear and doors and windows can be opened easily.

- Choose an outside meeting place (i.e. neighbor's house, a light post, mailbox, or stop sign) a safe distance in front of your home where everyone can meet after they've escaped. Make sure to mark the location of the meeting place on your escape plan.

- Go outside to see if your street number is clearly visible from the road. If not, paint it on the curb or install house numbers to ensure that responding emergency personnel can find your home.

- Have everyone memorize the emergency phone number of the fire department. That way any member of the household can call from a neighbor's home or a cellular phone once safely outside.

- If there are infants, older adults, or family members with mobility limitations, make sure that someone is assigned to assist them in the fire drill and in the event of an emergency. Assign a backup person too, in case the designee is not home during the emergency.

- If windows or doors in your home have security bars, make sure that the bars have emergency release devices inside so that they can be opened immediately in an emergency. Emergency release devices won't compromise your security - but they will increase your chances of safely escaping a home fire.

- Tell guests or visitors to your home about your family's fire escape plan. When staying overnight at other people's homes, ask about their escape plan. If they don't have a plan in place, offer to help them make one. This is especially important when children are permitted to attend "sleepovers" at friends' homes. See NFPA's "Sleepover fire safety for kids" fact sheet.

- Be fully prepared for a real fire: when a smoke alarm sounds, get out immediately. Residents of high-rise and apartment buildings may be safer "defending in place."

- Once you're out, stay out! Under no circumstances should you ever go back into a burning building. If someone is missing, inform the fire department dispatcher when you call. Firefighters have the skills and equipment to perform rescues.

Putting your plan to the test

- Practice your home fire escape plan twice a year, making the drill as realistic as possible.

- Make arrangements in your plan for anyone in your home who has a disability.

- Allow children to master fire escape planning and practice before holding a fire drill at night when they are sleeping. The objective is to practice, not to frighten, so telling children there will be a drill before they go to bed can be as effective as a surprise drill.

- It's important to determine during the drill whether children and others can readily waken to the sound of the smoke alarm. If they fail to awaken, make sure that someone is assigned to wake them up as part of the drill and in a real emergency situation.
- If your home has two floors, every family member (including children) must be able to escape from the second floor rooms. Escape ladders can be placed in or near windows to provide an additional escape route. Review the manufacturer's instructions carefully so you'll be able to use a safety ladder in an emergency. Practice setting up the ladder from a first floor window to make sure you can do it correctly and quickly. Children should only practice with a grown-up, and only from a first-story window. Store the ladder near the window, in an easily accessible location. You don't want to have to search for it during a fire.
- Always choose the escape route that is safest – the one with the least amount of smoke and heat – but be prepared to escape under toxic smoke if necessary. When you do your fire drill, everyone in the family should practice getting low and going under the smoke to your exit.
- Closing doors on your way out slows the spread of fire, giving you more time to safely escape.
- In some cases, smoke or fire may prevent you from exiting your home or apartment building. To prepare for an emergency like this, practice "sealing yourself in for safety" as part of your home fire escape plan. Close all doors between you and the fire. Use duct tape or towels to seal the door cracks and cover air vents to keep smoke from coming in. If possible, open your windows at the top and bottom so fresh air can get in. Call the fire department to report your exact location. Wave a flashlight or light-colored cloth at the window to let the fire department know where you are located.

Appendix F: EVO192 CP-01 Implications as of June 13th, 2014

Appendix G EVO192 CP-01 Installer Programming¹ Quick Reference Chart SIA False Alarm Reduction

Minimum requirement system for SIA CP-01 Installations:

- 1 EVO192 CP-01 Control Panel
- 2 Local Annunciation Devices

The local annunciation devices must be of the following keypads.

- K641/TM50

| CP-01 Paragraph | This Installation Manual (IM) | Feature | Range | Shipping default | Recommended Programming* |
|-------------------|---|--|---|--------------------------|---|
| 4.2.2.1 | <i>section 8.18</i> on page 58 | Exit time | 45 sec – 255 sec | 60 seconds | 60 seconds |
| 4.2.2.2 | Refer to Keypad(s) manual | Progress annunciation | Individual keypads may be disabled | All annunciators enabled | All annunciators enabled |
| 4.2.2.3 | Not programmable | Exit time restart | For re-entry during exit delay | Always Enabled | Cannot be disabled |
| 4.2.2.5 | <i>section 8.13</i> on page 57 | Auto Stay Arm on non-evacuated Premises | If no exit after full arm | Enabled | Enabled |
| 4.2.3.1 | <i>section 4.4.2</i> on page 33 | Entry delay(s) | 30 sec – 255 sec ² | 30 seconds | At least 30 sec ² |
| 4.2.5.1 | <i>section 4.6.8</i> on page 39 | Abort Window – for non-fire zones | May be disabled by zone | Enabled | Enabled (all zones) |
| 4.2.5.1 | <i>section 4.6.8</i> on page 39 | Abort Window time – for non-fire zones | 15 sec – 45 sec ² | 30 seconds | At least 30 sec ² |
| 4.2.5.1.2 | Not programmable | Abort annunciation | Annunciate that no alarm was transmitted | Always Enabled | Cannot be disabled |
| 4.2.5.4 | Not programmable | Cancel window | No limits | No limits | No limits |
| 4.2.5.4.1 | Not programmable | Cancel annunciation | Annunciate that a cancel was transmitted | Always Enabled | Cannot be disabled |
| 4.2.6.1 & 4.2.6.2 | <i>section 10.2.10</i> on page 70 and <i>section 15.6</i> on page 100 | Duress feature | No T+derivative of another user code. No duplicate with other user codes. | Disabled | Disabled |
| 4.3.1 | <i>section 4.6.7</i> on page 38 | Cross zoning | Programming needed | Disabled | Enabled and two (or more) zones programmed |
| 4.3.1 | <i>section 4.6.6</i> on page 36 | Programmable cross zoning | May Program | 48 sec. | Per walk path in protected premises |
| 4.3.2 | <i>section 4.6.1</i> on page 35 | Swinger shutdown | For all non-fire zones, shutdown at 1 or 2 trips | two trip | two trip |
| 4.3.3 | <i>section 2.22.3</i> on page 25 | Fire Alarm Verification | Depends on sensors | Disabled | Enabled unless sensors can self-verify |
| 4.5 | <i>section 11.9</i> on page 79 | Call waiting Cancel | Depends on user phone line | Disabled | Enabled if user has call waiting ³ |
| 4.6.3 | <i>section 7.3</i> on page 48 | System test (test report + walk test mode + siren) | Test periodically. | Disabled | Enabled to test all zones, siren, communicator ⁴ |

Caution

- For SIA CP-01 installations, only use modules / devices that are listed on this page.
- Fire Alarm Verification feature (Auto Verified Fire zone) is not supported for 2-wire smoke detectors zones. This feature may be enabled for 4-wire smoke detectors only.
- Call Waiting Cancel feature on a non-Call Waiting line will prevent successful communication to the central station, see note 3 below.
- All smoke detectors on the system must be tested annually by conducting the Installer Walk Test. Please refer to the smoke detector installation instructions on how to correctly test the detectors.

Notes

¹ Programming at installation may be subordinate to other UL requirements for the intended application.

² Combined Entry Delay and Abort Window should not exceed 1 minute.

³ For “Call Waiting” option. The installer needs to verify the code in the premises area for the telephone network that disables the call waiting feature, then add it to the monitoring station phone number. For example:

Receiving center phone number: 999-999-999
 Call waiting cancelation code: *70
 Phone number to program: *70P999999999

⁴ When the test initiates or terminates, the communicators (PSTN/GSM, LAN and GPRS) will report the test initiation/termination to the monitoring station. Automatic Termination of System Test Mode is not supported.

- Cross zones have the ability to individually protect the intended area (e.g., motion detectors, which overlap).
- Cross zoning is not recommended for line security Installations nor is it to be implemented on exit / entry zones.
- There is a communicator delay of 30 seconds in this control panel. It can be removed, or it can be increased up to 45 seconds at the option of the end user by consulting with the Installer.
- Do not duplicate any reporting codes. This applies for all communication formats other than SIA and Contact ID sending automatic programmed reporting codes.
- The control unit must be installed with a local sounding device and an off-premise transmission for SIA communication format.

• The control unit must be installed with a local sounding device and an off-premise transmission for SIA communication format. **K641/K641+/TM50 Must be in the Installation guides**

1. Add a note, in the LCD manual, near the mute programming statement: "Mute shall be disabled to comply with CP-01 standards."
2. Support new error messages :
 - a. No alarm was reported
 - b. Cancel alarm event reported

EVO192 BOARD LABELLING

3. VP27 Labeling (Ref. 4.4.2) Add a sticker on the main connector to indicate the operating voltage of the panel.

| | |
|--|---|
| Transformer: | UL: Universal UB1640W 17VAC 40VA |
| DC Power Supply rated at: | 1.7A |
| Auxiliary Supply can provide a maximum | typ: 600mA, max: 700mA Do not exceed 200mA for UL installation |
| Acceptable Battery Charge Currents | 350mA/700mA |

The panel will cease to process sensor trips if the voltage is under 8.5V. Rechargeable Battery UL/ULC - 12Vdc / 4Ah or 7Ah

UL Warning: A 12Vdc / 7Ah battery is required to comply with UL fire requirements.

Caution: Disconnect battery before replacing the fuse.

Note: Install

Note: Improper connection of the transformer may result in damage to the system.

4. Specify on the interconnect label, information that allows an installer to confirm compatibility between the panel zone inputs and the sensors selected for the installation. (ex. Annex J)

Zone Input Specifications:

- Maximum loop current (shorted loop): 2.2 mA

- Maximum loop voltage (open loop): 5.0 VDC
- See installation manual for zone input connections.

ADD THESE SECTIONS IN THE PROGRAMMING GUIDE, INSTALLER MANUAL AND/OR USER MANUAL

5. CP-01 options

- Section [3028]:
 - Option 3 : CP-01 Enabled (Default enabled). Note: If that option is 'Enabled' while performing a manual panel reset, the system will reset using CP-01 defaults settings. That option is not affected by a panel reset.
 - Option 4 : Auto verified fire zone(Default disabled) . This zone ensures that an alarm condition persists by resetting a tripped sensor in a fire zone and confirming that the sensor has remained tripped or is waiting for the sensor to re-trip within a set period of time (e.g., cycling power to a smoke detector to ensure the condition persists when power is restored). The alarm sequence for the zone is indicated below:
 - The event PGM event (04-01) is generated the first time an auto-verified fire zone is tripped. Program a PGM to activate on that event with a delay of 20 sec (to create a smoke reset).
 - If the zone is define on input one with the option 2-wire smoke input enabled (Section [706] option [3]), the panel will reset the smoke detector for 20 sec.
 - Step #1 Duration 20 Seconds Sensor Reset
 - Step #2 Duration 10 Seconds Settle Time (Power-up)
 - Step #3 Duration 60 Seconds Check for Verified Alarm

Note: If another Fire device detects Fire during the Auto Verify or Delay sequence, the sequence is terminated and alarms are immediately generated for all pending zones. This applies to all other Fire zones on the system (i.e., two fire alarms anywhere on the system will cancel all pending fire delays and create immediate alarms).

6. Call waiting cancel string.

- Program this before the telephone number *70P... To enable the call waiting
- Place a note near the programming on the CMS phone number (Section 3071 to 3074) to advise the installer to not use a call waiting cancel string on a non call waiting line and vice versa (do not use the call waiting cancel feature inappropriately). The system cannot use the Call waiting cancel feature when dialing backup telephone number to be cp-01.

7. Event list:

- Event 1E : Special alarm – Sub event 5 : Exit error by User

CHANGE THESE DEFAULTS IN THE PROGRAMMING GUIDE, INSTALLER MANUAL

8. Exit delay

- Section [3108] = 60 (CP-01 minimum 45 sec)
- Section [3208] = 60 (CP-01 minimum 45 sec)
- Section [3308] = 60 (CP-01 minimum 45 sec)
- Section [3408] = 60 (CP-01 minimum 45 sec)
- Section [3508] = 60 (CP-01 minimum 45 sec)
- Section [3608] = 60 (CP-01 minimum 45 sec)
- Section [3708] = 60 (CP-01 minimum 45 sec)
- Section [3808] = 60 (CP-01 minimum 45 sec)

9. Entry delay 1

- Section [3111] = 30 (CP-01 minimum 30 sec)
- Section [3211] = 30 (CP-01 minimum 30 sec)
- Section [3311] = 30 (CP-01 minimum 30 sec)
- Section [3411] = 30 (CP-01 minimum 30 sec)
- Section [3511] = 30 (CP-01 minimum 30 sec)
- Section [3611] = 30 (CP-01 minimum 30 sec)
- Section [3711] = 30 (CP-01 minimum 30 sec)
- Section [3811] = 30 (CP-01 minimum 30 sec)

10. Entry delay 2

- Section [3112] = 60 (CP-01 minimum 30 sec)
- Section [3212] = 60 (CP-01 minimum 30 sec)
- Section [3312] = 60 (CP-01 minimum 30 sec)
- Section [3412] = 60 (CP-01 minimum 30 sec)
- Section [3512] = 60 (CP-01 minimum 30 sec)
- Section [3612] = 60 (CP-01 minimum 30 sec)
- Section [3712] = 60 (CP-01 minimum 30 sec)
- Section [3812] = 60 (CP-01 minimum 30 sec)

11. Delay alarm transmission

- Section [3055] = 30 (CP-01 min 15 sec, max 45 sec)

12. Zone definition options

- a. 'Delay alarm transmission' enabled by default for all zones.
- b. 'Force zone' disabled by default for all zones.

13. Auto Zone Shutdown Counter Section [712] = 1 (CP-01 default)

- a. Section [3114] = 2 (CP-01 maximum 6)
- b. Section [3214] = 2 (CP-01 maximum 6)
- c. Section [3314] = 2 (CP-01 maximum 6)
- d. Section [3414] = 2 (CP-01 maximum 6)
- e. Section [3514] = 2 (CP-01 maximum 6)
- f. Section [3614] = 2 (CP-01 maximum 6)
- g. Section [3714] = 2 (CP-01 maximum 6)
- h. Section [3814] = 2 (CP-01 maximum 6)

14. Partition options : enabled : Switch to stay arming if no zone entry delay is opened

- a. Section [3121] option 1 enabled
- b. Section [3221] option 2 enabled
- c. Section [3321] option 3 enabled
- d. Section [3421] option 4 enabled
- e. Section [3521] option 5 enabled
- f. Section [3621] option 6 enabled
- g. Section [3721] option 7 enabled
- h. Section [3821] option 8 enabled

15. Arming/Disarming options : Exit delay termination

- a. Section [3122] option 4 disabled
- b. Section [3222] option 4 disabled
- c. Section [3322] option 4 disabled
- d. Section [3422] option 4 disabled
- e. Section [3522] option 4 disabled
- f. Section [3622] option 4 disabled
- g. Section [3722] option 4 disabled
- h. Section [3822] option 4 disabled

ADD THESE NOTES TO THE INSTALLER MANUAL

16. At the beginning of the manual.

- a. To comply with CP-01 standards, your system must be setup like this:
 - i. All system keypads must be audible (Mute disabled).
 - ii. A minimum of 2 must be installed to comply with CP-01 standards.
 - iii. To be CP-01, remote panic action shall be programmed on combined button only ().

17. Recent closing delay.

- a. If the option CP-01 is enabled (section [3028] opt 3), the recent closing delay will always be set to 120 sec and will not take care of the programmed value.

18. Delay Alarm Transmission:

- a. In accordance with UL standards, the Abort Window standard intends that the aggregate of the Entry Delay and Abort Window will not be programmed to exceed one minute.
- b. Non-effective on fire zones

19. Auto zone shutdown.

- a. Auto zone shutdown counter is reset every 48 hours of no movement.

20. Intellizone

- a. Sections [400]: Zones [001] to [192]
Option [7] OFF = Intellizone Disabled (default)
Option [7] ON = Intellizone Enabled for Selected Zone
This feature reduces the possibility of false alarms. When a zone with the Intellizone option opens, the panel does not immediately generate an alarm. First it triggers the Intellizone Delay Timer. To program the Intellizone Delay Timer, key in the desired 3-digit value (000 to 255 seconds, Default = 48 seconds) into section [3x10](x = 1-8). If any of the following conditions occur during this period, the panel will generate an alarm:
 - During the Intellizone Delay, a second zone has caused an alarm.
 - During the Intellizone Delay, the zone in alarm has restored (closed) and re-occurred (opened). (Area options section [3x26](x=1-8) option 2 must be disabled)
 - The zone in alarm remains open for the entire Intellizone Delay. (Area options section [3x26](x=1-8) option 2 must be disabled)

21. Zone input specifications

- a. Maximum loop current (shorted loop): 2.2 mA
- b. Maximum loop voltage (open loop): 5.0 VDC

- c. Connection for single zone input with end of line resistor (1000 ohms) OR Connection for double serial zone input with end of line resistor (1000 ohms).
 - i Loop short 0.0V – 0.90V. (0 - 630 ohms total loop resistance)
 - ii Loop normal 1.10V – 1.40V. (770 - 1170 ohms)
 - iii Loop open 1.65V – 5.0V. (1430 to infinite ohms)

ADD THESE NOTES TO THE USER MANUAL

22. User

- a. Cannot duplicate a user code or create a user code +/- 1.

23. System options

- a. Siren squawk on arm/disarm with keypad.
 - i This features must be enabled to comply with CP-01 standards.

24. There is a communicator delay of 30 seconds in this control panel. It can be removed, or it can be increased up to 45 seconds at the option of the end user by consulting with the Installer.

25. Keypad muting

- a. Do not mute keypads to comply with CP-01 standards.

UNDOCUMENTED CHANGES

26. We stop the buzzer on all keypads upon entry of a code/action key. It's resume if the code is invalid or after 20 sec of no key pressed.

27. Create a quick reference chart or card to details all programming locations for the features in the standard and their associated test procedures (walk test, test report).

28. A cancel event will be reported if an alarm is cancelled. The cancel window for that event is infinite (no time limit).

Appendix H: EVO192 CP-01 Installer Programming Quick Reference Chart SIA False Alarm Reduction

Minimum requirement system for SIA-FAR Installations :

- EVO192 CP-01 Control Panel
- Local Annunciation Devices

The local annunciation devices must be the following keypads.

- K641/K641+/TM50

| CP-01 Paragraph | Installation Manual (IM) / User Manual (UM) | Feature | Range | Shipping default | Recommended Programming* |
|-------------------|---|--|---|--------------------------|--|
| 4.2.2.1 | (IM) 10.15 | Exit time | 45 sec – 255 sec | 60 seconds | 60 seconds |
| 4.2.2.2 | (UM) Keypad muting | Progress annunciation | Individual keypads may be disabled | All annunciators enabled | All annunciators enabled |
| 4.2.2.3 | (IM) 10.XX | Exit time restart | For re-entry during exit delay | Always Enabled | Cannot be disabled |
| 4.2.2.5 | (IM) 10.1 | Auto Stay Arm on Unvacated Premises | If no exit after full arm | Enabled | Enabled |
| 4.2.3.1 | (IM) 7.1.1 to 7.1.4 | Entry delay(s) | 30 sec – 255 sec** | 30 seconds | At least 30 sec** |
| 4.2.5.1 | (IM) 7.4.6 | Abort Window – for non-fire zones | May be disabled by zone | Enabled | Enabled (all zones) |
| 4.2.5.1 | (IM) 7.4.6 | Abort Window Time – for non-fire zones | 15 sec – 45 sec** | 30 seconds | At least 30 sec** |
| 4.2.5.1.2 | (IM) 14.15 | Abort annunciation | Annunciate that no alarm was transmitted | Always Enabled | Cannot be disabled |
| 4.2.5.4 | (IM) 14.16 | Cancel window | No limits | No limits | No limits |
| 4.2.5.4.1 | (IM) 14.16 | Cancel annunciation | Annunciate that a cancel was transmitted | Always Enabled | Cannot be disabled |
| 4.2.6.1 & 4.2.6.2 | (IM) 5.5.8 | Duress feature | No 1+derivative of another user code. No duplicate with other user codes. | Disabled | Disabled |
| 4.3.1 | (IM) 7.4.5 | Cross zoning | Programming needed | Disabled | Enabled and two (or more) zones programmed |
| 4.3.1 | (IM) 7.4.5 | Programmable cross zoning | May Program | 48 sec. | Per walk path n protected premises |
| 4.3.2 | (IM) 7.4.1 | Singer shutdown | For all non-fire zones, shutdown at 1 or 2 trips | two trip | two trip |
| 4.3.3 | (IM) 7.1.27 | Fire Alarm Verification | Depends on sensors | Disabled | Enabled unless sensors can self verify |
| 4.5 | (IM) XX | Call waiting Cancel | Depends on user phone line | Disabled | Enabled if user has call waiting |
| 4.6.3 | (IM) 14.8 | System test (test report + walk test mode + siren) | Test periodically. | Disabled | Enabled to test all zones, siren, communicator |

Caution:

- For SIA FAR installations, only use modules / devices that are listed on this page.
- Fire Alarm Verification feature (Auto Verified Fire zone) is not supported on 2-wire smoke detectors zones. This feature may be enabled for 4-wire smoke detectors only.
 - Call Waiting Cancel feature on a non-Call Waiting line will prevent successful communication to the central station.
- All smoke detectors on the system must be tested annually by conducting the Installer Walk Test. Please refer to the smoke detector installation instructions on how to correctly test the detectors.

Note:

- *Programming at installation may be subordinate to other UL requirements for the intended application.
- **Combined Entry Delay and Abort Window should not exceed 1 minute.
- Cross zones have the ability to individually protect the intended area (e.g., motion detectors, which overlap).
- Cross zoning is not recommended for line security Installations nor is it to be implemented on exit / entry zones.
- There is a communicator delay of 30 seconds in this control panel. It can be removed, or it can be increased up to 45 seconds at the option of the end user by consulting with the Installer.
- Do not duplicate any reporting codes. This applies for all communication formats other than SIA and Contact ID sending automatic programmed reporting codes.
- The control unit must be installed with a local sounding device and an off-premise transmission for SIA communication format.

Appendix I: Warnings

FCC Warnings

IMPORTANT INFORMATION

This equipment complies with Part 68 of the FCC rules subpart D and CS-03. Inside the cover of this equipment is a label that contains, among other information, the FCC registration number of this equipment.

notification to telephone company

Upon request, customer shall notify telephone company of particular line to which the connection will be made and provide the FCC registration number and the ringer equivalence of the protective circuit.

| | |
|-----------------------------------|--|
| FCC REGISTRATION NUMBER: | 5A7CAN-22633 - AL - E |
| RINGER EQUIVALENCE NUMBER: | 0.1B (U.S. & CANADA) |
| USOC JACK: | RJ31X (USA), CA31A (CANADA) |

TELEPHONE CONNECTION REQUIREMENTS

Except for telephone company provided ringers, all connections to the telephone network shall be made through standard plugs and telephone company provided jacks, or equivalent, in such a manner as to allow for easy, immediate disconnection of terminal equipment. Standard jacks shall be so arranged that, if plug connected thereto is withdrawn, no interference to operation of equipment at customer's premises which remains connected to telephone network shall occur by reason of such withdrawal.

INCIDENCE OF HARM

Should terminal equipment/protective circuitry cause harm to telephone network, telephone company shall, where practicable, notify customer that temporary disconnection of service may be required; however, where prior notice is not practicable, the telephone company may temporarily discontinue service if action is deemed reasonable in circumstances. In case of temporary discontinuance, telephone company shall promptly notify customer and will be given opportunity to correct the situation.

CHANGES IN TELEPHONE COMPANY EQUIPMENT OR FACILITIES

The telephone company may make changes in its communication facilities, equipment operations or procedures, where such actions are reasonably required and proper in its business. Should any such changes render customer's terminal equipment incompatible with the telephone company facilities, the customer shall be given adequate notice to effect the modifications to maintain uninterrupted service.

GENERAL

This equipment shall not be used on coin telephone lines. Connection to party line service is subject to state tariffs.

RINGER EQUIVALENCE NUMBER (REN)

The REN is useful to determine the quantity of devices that you may connect to your telephone line and still have all of those devices ring when your telephone number is called. In most, but not all areas, sum of the REN's of all devices connected to one line should not exceed five (5). To be certain of the number of devices that you may connect to your line, you may want to contact your local telephone company.

EQUIPMENT MAINTENANCE FACILITY

If you experience trouble with this telephone equipment, please contact facility indicated below for information on obtaining service or repairs. The telephone company may ask that you disconnect this equipment from network until problem is corrected or until you are sure that the equipment is not malfunctioning.

FCC PART 15, WARNINGS: INFORMATION TO USER

This equipment has been tested and found to comply with the limits for Class B digital devices, pursuant to Part 15 of FCC rules. These limits are designed to provide reasonable protection against harmful interference in a residential installation. This equipment generates, uses and can radiate radio frequency energy, and, if not installed and used in accordance with the instructions, may cause harmful interference to radio communications. However, there is no guarantee that interference will not occur in a particular installation. If this equipment does cause harmful interference to equipment intermittently, the user is encouraged to try to correct the interference by one or more of the following measures: (1) reorient or relocate the receiving antenna; (2) increase the separation between the equipment and receiver; (3) connect the equipment to an outlet on a circuit other than the one to which the receiver is connected, or (4) consult the dealer or an experienced radio/tv technician for assistance.

CAUTION:

Changes or modifications not expressly approved by PARADOX SECURITY SYSTEMS could void the user's authority to operate the equipment.

ETL and ETLIC Warnings

ETL AND ETLIC INSTALLATION NOTES

The control panel (EVO) and LCD Keypad (K641) are UL listed in accordance with standard UL1023 (Household Burglar -- Alarm Systems Units), standard UL985 (Household Fire Warning Units), standard UL1635 (Digital Alarm Communicator System Units), standard UL609 (Local Burglar Alarm Units and Systems), standard UL365 (Police Station Connected Burglar Alarm Units and Systems) and standards UL1610 (Monitoring Station Burglar Alarm Units). This equipment has the capability of being programmed with features and connected to modules not verified for use in UL installations. To stay within these standards, the installer should use the following guidelines when configuring the system:

- All components of the system should be UL listed for the intended application.
- If the system will be used for "Fire" detection, the installer should refer to NFPA Standards #72, Chapter 2. In addition, once installation is complete, the local fire authority must be notified of the installation.
- This equipment must be verified by a qualified technician once every three years.
- All keypads must use a tamper switch.
- Maximum allowed entry delay is 45 seconds.
- Maximum allowed exit delay is 60 seconds.
- Minimum 4 minutes for bell cut-off time.
- The following features do not comply with UL requirements: Bypass Recall, Shabbat, Auto Trouble Shutdown, and "No AC Fail" display.
- Do not connect the primary indicating device to a relay. The installer must use the bell output.
- All modules installed on the system must be UL listed in accordance with the standards listed above.
- The metallic enclosure must be grounded to the cold water pipe.

For further details concerning the above information, refer to the UL standards listed and/or the Underwriters Laboratories Inc. Standard for Safety's *Installation and Classification of Burglar and Holdup Alarm Systems*.

The communication medium between protected property and communications service provider shall be for the exclusive use of the protected property and is not to be shared with other communications service provider subscribers.

Recommended:

- EOL resistor part #2011002000
- Transformers: (Use a 17Vac (50/60Hz) transformer with a minimum 40VA rating. For residential installations use transformer made by Universal Power Group model: UB1640W
- AC/AC transformer:
For US: UL/ETL Listed Class 2 wall/building 120VAC/60Hz power supply with restraining means.
For Canada: CSA/ULc/ETLc Listed Class 2 Power Supply with NO restraining means
- For CSA listed systems, use Basler Electronics' transformer model #BE116240AAA.
- 12Vdc 7Ah rechargeable acid/lead backup battery (YUASA model #NP7-12 recommended) for residential use. 7Ah battery to comply with fire requirements.

All outputs are Class 2 or power-limited, except for the battery terminal. The Class 2 and power-limited fire alarm circuits shall be installed using CL3, CL3R, CL3P, or substitute cable permitted by the National Electrical Code, ANSI/NFPA 70.

The control unit and keypads are intended to be programmed and installed as follows:

Household Fire Warning Systems (US and Canada)

- At least one model K641 keypad shall be used with the system.
- One listed audible device rated to operate over the range of 11.4 to 12.5Vdc and rated 85db minimum is required for this application. For example, Wheelock model 46T-12 is compatible. The bell cutoff time shall be programmed for a minimum of 4 minutes (5 minutes for Canada).
- The fire alarm initiating circuit shall employ the listed model 2011002000-PRT end-of-line resistor.
- For Canadian systems, the secure screw for the listed Class 2 transformer shall not be employed.

Household Grade A Burglar Alarm system Unit (US and Canada)

- At least one listed audible device rated to operate over the range of 11.4 to 12.5Vdc and rated 85db minimum. For example, Wheelock model 46T-12 is compatible.
- At least one model K641 keypad shall be used.
- All initiating circuits shall be programmed and installed as end-of-line supervised.
- Burglar alarm initiating devices shall be rated to operate over the range of 11.4 to 12.5Vdc.
- The bell cutoff time shall be programmed for a minimum of 4 minutes.
- The maximum entry delay shall not exceed 60 seconds. The maximum exit delay shall not exceed 45 seconds.
- For Canadian systems, the secure screw for the listed Class 2 transformer shall not be employed.

Grade B Monitoring Station (Level 0)

Same as Household Grade A Burglar alarm system unit except:

- The ringback feature shall be enabled (section [3037] option [5]).
- The model AB12M Bell and Bell Housing, manufactured by ADEMCO shall be employed. Bell cutoff time shall be programmed for a minimum of 15 minutes (30 minutes for Canada).
- The Auto Test Report setting must be programmed to send a test transmission to the monitoring station at least once every 24 hours (section [3037] options [3] and [4] and section [3041]).
- Openings and closings must be reported to the monitoring station. Report codes shall be enabled.
- Model 278-0000-035 attack resistant enclosure must be employed.

Grade C Monitoring Station (Level 0)

Same as Grade B Monitoring Station except the Grade A Bell housing may not be employed.

Grade A Local Alarm Units (Level 0)

Same as Grade B Monitoring Station except:

- Bell test must be enabled.

Police Station Connect with Basic Line Security (Level 0)

Same as Grade B Monitoring Station except:

- Openings and closings may not be reported to the monitoring station.

Access Control System

- At least one model K641R keypad shall be used with the system.
- The listed compatible model DGP-R915 reader shall be employed off the keypad.

Control of the Protected Premise

In order to have a UL certified system, the protected area is to be under the responsibility of one ownership and management (i.e. one business under one name). This may be a group of buildings attached or unattached with different addresses but under the responsibility of someone having mutual interest. The person of mutual interest is not the alarm installing company.

Bell Location

The alarm sounding device (bell) must be located where it can be heard by the person or persons responsible for maintaining the security system during the daily arming cycle.

Protection of the Control Unit

The local control unit and the local power supply must be protected by one of the following ways:

- The control unit and audible alarm device must be in a protected area, which is armed 24 hours a day.
- Each partition shall arm the area protecting the control unit and the audible alarm device power supply. This may require duplicate protection armed by each partition. Access to this protected area, without causing an alarm, will require that all partitions be disarmed

In all cases described above, the protected area for the control unit must be programmed as not bypassable.

CTR-21 Warnings

The equipment has been approved in accordance with Council Decision 98/482/EC for pan-European single terminal connection to the public switched telephone network (PSTN). However, due to differences between the individual PSTNs provided in different countries, the approval does not, of itself, give an unconditional assurance of successful operation on every PSTN network termination point. In the event of problems, you should contact your equipment supplier in the first instance.

General Warning

This equipment must be installed and maintained by qualified service personnel only.

Warranty

For complete warranty information on this product please refer to the Limited Warranty Statement found on the website www.paradox.com/terms. Your use of the Paradox product signifies your acceptance of all warranty terms and conditions.

ATTACHMENT LIMITATION NOTICE

The Industry Canada label identifies certified equipment. This certification means that the equipment meets certain telecommunications network protective, operational and safety requirements. The Department does not guarantee the equipment will operate to the user's satisfaction.

Before installing this equipment, users should ensure that it is permissible to be connected to the facilities of the local telecommunications company. The equipment must also be installed using an acceptable method of connection. The customer should be aware that compliance with the above conditions may not prevent degradation of service in some situations.

Repairs to certified equipment should be made by an authorized Canadian maintenance facility designated by the supplier. Any repairs or alterations made by the user to this equipment, or equipment malfunctions, may give the telecommunications company cause to request the user to disconnect the equipment.

Users should ensure for their own protection that the electrical ground connections of the power utility, telephone lines and internal metallic water pipe system, if present, are connected together. This precaution may be particularly important in rural areas.

CAUTION: Users should not attempt to make such connections themselves, but should contact the appropriate electrical inspection authority, or electrician, as appropriate.

The Load Number (LN) assigned to each terminal device denotes the percentage of the total load to be connected to a telephone loop which is used by the device to prevent overloading. The termination on a loop may consist of any combination of devices subject only to the requirement that the total of the Load Numbers of all of the devices does not exceed 100.

Industry Canada certification is only applicable to installation of devices which include transformers approved by the Canadian Standards Association (CSA).

© 2002-2007 Paradox Security Systems Ltd.

Digiplex EVO, WinLoad, Magellan, NEware and InTouch are trademarks or registered trademarks of Paradox Security Systems Ltd. and its affiliates in Canada, the United States and/or other countries. All rights reserved.

Index

Numerics

24Hr Zones 34

A

AC Failure not Displayed 92

AC Power 17

Access Code Length 97

Access Codes 97

Account Number 73

Account Number Transmission 73

Ademco Contact ID 73, 74

Ademco Express 74

Ademco slow 73

Advanced Technology Zoning (ATZ) 33

Alarm Transmission Delay. See Delay Alarm Transmission

Alarm Types 36

Alternate Dialing Option 75

Always Force Arm 57

Answer WinLoad 90

Arming Follows Partition 55

Arming/Disarming Reporting 71

Arming/Disarming Schedule Tolerance Window 72

Assigning keyswitches to partitions 43

Audible Alarm 64

 Bell Cut-off Timer 61

 Pulsed 36

 Steady 36

Auto Force on Stay Arming 58

Auto Report Code Programming 77

Auto Test Report Period 76

Auto Trouble Shutdown 92

Auto Zone Shutdown 35

Auto Zone Shutdown Limit 35

Auto-Arming

 Timed 56

 Timer 56

Auto-Arming Options 57

Automatic report code list 101

Auxiliary Power 17

 Calculating power consumption 19

 Power Limitations 20

 Power Supply Connections 22

Away Zones. See Force Zones

B

Battery 17

 Battery Test 17

Battery Charge Current 89

Baud Rate 89

Bell

 Bell/siren Output 17

 Bell/Siren Output During Fire Alarm 35

Bell On Communication Fail 79

Bell Squawk 59

Bell/alarm Output 61

- Broadcast 91
- Burglary Zones 34
- Bus Connection in Noisy Environments 25
- Bus Speed 89
- Busy Tone Detection 78
- Buzzer Zones 34
- Bypass Zones 36
- C
- Call Direction 74
- Call WinLoad 90
- Cancel Communication 90
- Closing Delinquency Timer 77
- Codes
 - Special Alarm Report Codes 69
 - Special Arming Report Codes 68
 - Special Disarming Report Codes 69
 - System Trouble Codes 70
 - System Trouble Restore Codes 71
- Connecting the Bus in Noisy Environments 25
- Connections
 - Bus Connections 24
 - Double Zone Connections 24
 - Keypad Zone Connections 21
 - Keyswitch Connections 18
 - Power 17
 - Single Zone Connections 22
- Contact ID Pager 74
- Contact ID Report Code List 104
- D
- Daylight Savings Time 88
- Daylight Savings Time Schedule 88
- Delay Alarm Transmission 39
- Delay Alarm Transmission Timer 39
- Delay Between Dialing Attempts 75
- Delayed 24Hr Fire Zone 34
- Delinquency Timer, Closing 77
- Dial Tone Delay 79
- Digiplex Memory Key. See Paradox Memory Key
- Disarm Reporting Options 76
- Display "Bypass" If Armed 60
- Door Labels 92
- Double Zone Connections 24
- Duress 100
- E
- Earth Ground 17
- Enable Reporting 67
- End # 85
- Entry Delay Timer 33
- Entry Delay Timers 33
- EOL Zones 39
- ESL CleanMe™ Installation 25
- Event Group 85
- Exit Delay 58
- Exit Delay cancelled on Remote Arm 59
- Exit Delay Termination 59

F

- Feature Group 85
- Feature Select Programming 29
- Fire Alarm 64
- Fire Circuits 25
- Fire Zone 25
 - Delayed 24Hr 34
 - Standard 24Hr 35
- Follow Zone Switches to Entry Delay 2 58
- Force Zones 36
- Freeze Zones 34
- Function Keys, Installer 90

G

- Gas Zones 34
- Ground 17

H

- Hardware Reset 87
- Heat Zones 34
- Hold-up Zones 34
- Hourly Test Transmission 76

I

- Input Numbers
 - Keyswitch Numbering 42
- Input Speed 39
- Installation Procedure 13
- Installer Code 97
- Installer Function Keys 90
- Installer Lock 88
- Installer Test Mode 90
- Instant zone 34
- Intellizone 36
- Intellizone Delay 36

K

- Keypad Beep on Successful Arm/Disarm Report 79
- Keypad Installation Instructions 106
- Keypad Lockout 59
- Keypad Numbering 39
- Keypad Zone Connections 21
- Keyswitch
 - Arm Only 43
 - Connections 18
 - Definitions 42
 - Disabled 42
 - Keyswitch Numbering 42
 - Maintained 42
 - Momentary 42
 - Options 43
 - Partition Assignment 43
 - Stay/Instant Disarm 43

L

- Label Broadcast 91
- Label Programming 92
- LCD Display
 - Shabbat Feature 90
- Locate Module 91
- Location & Mounting 13
 - EVO Installation Guide

Lock-out 59

M

Master 100

Maximum Bypass Entries 60

Maximum Dialing Attempts 75

Message Programming. See Label Programming

Module Broadcast 28, 91

Module Reset 91

Module Scan 90

Module Scanning 91

Multiple Action Feature 92

N

No AC Fail Display 92

No Bell Cut-Off on Fire Alarm 61

No Exit Delay on Remote Arm 59

No Movement Schedule 57

Noisy Environments 25

O

One-touch Features 58

P

Pager Format 74

Pager Reporting Format 74

Panel Partition Assignment 89

Panic Options 63

Paradox Memory Key 28

Partition Labels 93

Partitioning 89

PGM

PGM Activation Event 84

PGM Deactivation Event 85

PGM Deactivation Option 84

PGM Delay Timers 85

PGM Time Base Selection 85

PGM Initial Status 86

Police Code Timer 62

Postpone Auto-Arming 56

Power Failure Report Delay 75

Power Failure Restore Report Delay 76

Power Save Mode 92

Power Supply Connections 22

Procedure to Install 13

Programmable Outputs 18

As a 2-wire smoke detector 25

As a 4-wire smoke detector 25

Connections 18

Relay 18, 84

Programming 29

Decimal Programming 29

Feature Select Method 29

Hexadecimal Programming 29

Modules 91

Zone Programming 31

Pulse Dialing 79

Pulse formats. See Standard Pulse Formats

Pulse Ratio 78

Pulsed Audible Alarm 36

Q

Quick Module Scanning 91

R

Recent Close Delay 75

Recycle Alarm 61

Recycle Delay 61

Repeat Pager Report Code Transmission 76

Report Code, Repeat Pager 76

Report Only 36

Reporting Formats 73

Reset

Hardware 87

Module 91

Software 87

Restrict Arming on

AC Failure 55

Battery Failure 55

Bell or Auxiliary Failure 56

Module Troubles 56

Supervision Loss 55

Tamper 55

TLM Failure 56

Ring-back 60

RTC 27

S

Schedule Tolerance Window for Arming/Disarming 72

Serial Port Baud Rate 89

Serial Port Transmission of Zone Status 89

Sescoa 73

Shabbat Feature 90

SIA FSK 73, 74

Silent Alarm 36, 63

Silent Knight fast 73

Sirens 17

Special Arming Exit Delay 59

Special Characters 93

Special Telephone Number Keys 72

Speed, Bus 89

Standard 24Hr Fire Zone 35

Standard Pulse Formats 74

Start # 85

Stay Zones 36

Supervision Bypass Options 62

Switch To Pulse 79

Switch To Stay Arming 57

System Date and Time 91

System Labels 92

System Master Code 97

T

Tamper Bypass Options 63

Telephone Line Connection Examples 26

Telephone Line Connections 26

Telephone Line Monitoring (TLM) 78

Test Report 90

Test reports 76

Timed and Hourly Test Transmission 76

Timed Test Transmission when Armed/Disarmed 76

TLM Fail Timer 78

Tolerance Window 72

Transformer 17, 134

Transmit Zone Status on Serial Port 89

U

User Access Codes 97

User Labels. See Access Codes

User Menu Access 100

Utility Key 42

W

Water Zones 34

WinLoad 28

 Answer WinLoad 90

 Call WinLoad 90

 Cancel Communication 90

Wireless Transmitter Supervision Options 61

Z

Zone Labels 92

Zone Restore Report Options 76

Zone Status Transmission to Serial Port 89

Zones

 24Hr Burglary zone 34

 24Hr Buzzer 34

 24Hr Freeze zone 34

 24Hr Gas zone 34

 24Hr Heat zone 34

 24Hr Hold-up zone 34

 24Hr Water zone 34

 Alarm Transmission Delay 39

 Bypass 36

 Connections 22

 Definition 33

 Delayed 24Hr Fire Zone 34

 Disabled 33

 Doubling 33

 EOL 39

 Force Zone 36

 Generates a report only 36

 Intellizone 36

 Partition Assignment 35

 Pulsed Audible Alarm 36

 Silent Alarm 36

 Standard 24Hr Fire Zone 35

 Stay Zone 36

 Steady Audible Alarm 36

 Zone Doubling (ATZ) 33

 Zone Options 35

The whole Paradox team wishes you a successful and easy installation.
We hope this product performs to your complete satisfaction.
Should you have any questions or comments, please contact us.

For support, please contact your local distributor, or dial +1-450-491-7444,
Monday to Friday, from 8:00 a.m. to 5:00 p.m. EST.
You may also e-mail us at support@paradox.com.
Additional information can be found at PARADOX.COM

EVO192-EI04